

Digital Palmcorder®

**Panasonic®**

Digital Video Camcorder  
**Operating Instructions**  
Model No. **PV-DV121**

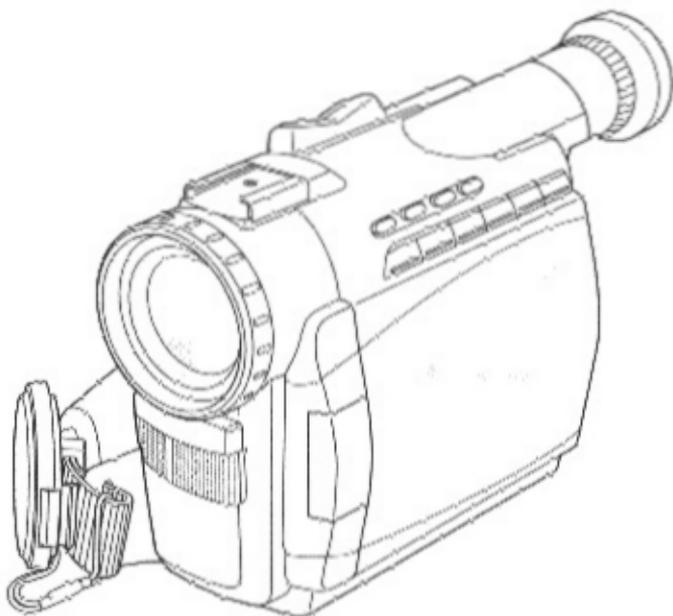

**MultiMediaCard™**



Mini **DV**

Before attempting to connect, operate or adjust this product, please read these instructions thoroughly.

Spanish Quick Use Guide is included.

Guía para rápida consulta en español está incluida.

For assistance, please call : 1-800-211-PANA(7262) or  
send e-mail to : [consumerproducts@panasonic.com](mailto:consumerproducts@panasonic.com)



# Things You Should Know

## Thank you for choosing Panasonic!

You have purchased one of the most sophisticated and reliable products on the market today. Used properly, we're sure it will bring you and your family years of enjoyment. Please take time to fill in the information below. The serial number is on the tag located on the underside of your Palmcorder. Be sure to **retain this manual** as your convenient Palmcorder information source.

Date of Purchase

Dealer Purchased From

Dealer Address

Dealer Phone No.

Model No.

Serial No.

## Safety Precautions

### WARNING: TO PREVENT FIRE OR SHOCK HAZARD, DO NOT EXPOSE THIS EQUIPMENT TO RAIN OR MOISTURE.

Your <sup>Mini</sup> **DX** Palmcorder is designed to record and play back in Standard Play (SP) mode and Long (LP) mode.

It is recommended that only cassette tapes that have been tested and inspected for use in VCR machines with the <sup>Mini</sup> **DX** mark be used.

 <b>CAUTION</b> RISK OF ELECTRIC SHOCK DO NOT OPEN			This symbol warns the user that uninsulated voltage within the unit may have sufficient magnitude to cause electric shock. Therefore, it is dangerous to make any kind of contact with any inside part of this unit.
CAUTION: TO REDUCE THE RISK OF ELECTRIC SHOCK, DO NOT REMOVE COVER (OR BACK) NO USER-SERVICEABLE PARTS INSIDE REFER SERVICING TO QUALIFIED SERVICE PERSONNEL			This symbol alerts the user that important literature concerning the operation and maintenance of this unit has been included. Therefore, it should be read carefully in order to avoid any problems.

### The above markings are located on the appliance bottom cover.

This device complies with Part 15 of the FCC Rules. Operation is subject to the following two conditions: (1) This device may not cause harmful interference, and (2) this device must accept any interference received, including interference that may cause undesired operation.

**Note:** This equipment has been tested and found to comply with Part 15 of the FCC Rules. These limits are designed to provide reasonable protection against harmful interference when operated in a residential environment.

If this equipment does cause interference to radio or television reception, which can be determined by turning the equipment off and on, use the equipment in another location and/or utilize an electrical outlet different from that used by the receiver.

If necessary, consult the dealer or an experienced radio/TV technician for help. You may find the booklet, 'Something About Interference' available from FCC local regional offices helpful.

**FCC Warning:** To assure continued FCC compliance, use only the provided shielded interface cable when connecting digital video camera to computer in accordance with instruction herein. Also, any unauthorized changes or modifications to this equipment could void the user's authority to operate.

# Important Safeguards

1. **Read Instructions** — All the safety and operating instructions should be read before the unit is operated.
2. **Retain Instructions** — The safety and operating instructions should be retained for future reference.
3. **Heed Warnings** — All warnings on the unit and in the operating instructions should be adhered to.
4. **Follow Instructions** — All operating and maintenance instructions should be followed.
5. **Cleaning** — Unplug this video unit from the wall outlet before cleaning. Do not use liquid or aerosol cleaners. Use a dry cloth for cleaning.
6. **Attachments** — Do not use attachments not recommended by the video product manufacturer as they may be hazardous.
7. **Water and Moisture** — Do not use this video unit near water — for example near a bath tub, wash bowl, kitchen sink, or laundry tub, in a wet basement, or near a swimming pool, and the like.
8. **Accessories** — Do not place this video unit on an unstable cart, stand, tripod, bracket, or table. The video unit may fall, causing serious injury to a child or adult, and serious damage to the unit. Use only with a cart, stand, tripod, bracket, or table recommended by the manufacturer, or sold with the video unit. Any mounting of the unit should follow the manufacturer's instructions and should use a mounting accessory recommended by the manufacturer. An appliance and cart combination should be moved with care. Quick stops, excessive force, and uneven surfaces may cause the appliance and cart combination to overturn.
9. **Ventilation** — Slots and openings in the cabinet are provided for ventilation and to ensure reliable operation of the video unit and to protect it from overheating. These openings must not be blocked or covered. Never place the video unit on a bed, sofa, rug, or other similar surface, or near or over a radiator or heat register. This video unit should not be placed in a built-in installation such as a bookcase or rack unless proper ventilation is provided or the manufacturer's instructions have been adhered to.



10. **Power Sources** — This video unit should be operated only from the type of power source indicated on the marking label. If you are not sure of the type of power supply to your home, consult your appliance dealer or local power company. For video units intended to be operated from battery power, or other sources, refer to the operating instructions.

11. **Grounding or Polarization** — This video unit may be equipped with either a polarized 2-wire AC (Alternating Current) line plug (a plug having one blade wider than the other) or 3-wire grounding type plug, a plug having a third (grounding) pin. The 2-wire polarized plug will fit into the power outlet only one way. This is a safety feature. If you are unable to insert the plug fully into the outlet, try reversing the plug. If the plug still fails to fit, contact your electrician to replace your obsolete outlet. Do not defeat the safety purpose of the polarized plug. The 3-wire grounding type plug will fit into a grounding type power outlet. This is a safety feature. If you are unable to insert the plug into the outlet, contact your electrician to replace your obsolete outlet. Do not defeat the safety purpose of the grounding type plug.
12. **Power-Cord Protection** — Power-supply cords should be routed so that they are not likely to be walked on or pinched by items placed upon or against them, paying particular attention to cords of plugs, convenience receptacles, and the point where they exit from the unit.
13. **Outdoor Antenna Grounding** — If an outside antenna or cable system is connected to the video unit, be sure the antenna or cable system is grounded so as to provide some protection against voltage surges and built-up static charges. Part 1 of the Canadian Electrical Code, in USA Section 810 of the National Electrical Code, provides information with respect to proper grounding of the mast and supporting structure, grounding of the lead-in wire to an antenna discharge unit, size of grounding conductors, location of antenna discharge unit, connection to grounding electrodes, and requirements for the grounding electrode.

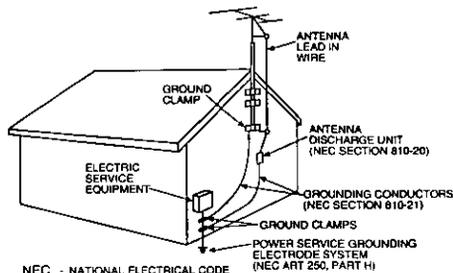

14. **Lightning** — For added protection of this video unit receiver during a lightning storm, or when it is left unattended and unused for long periods of time, unplug it from the wall outlet and disconnect the antenna or cable system. This will prevent damage to the video unit due to lightning and power-line surges.

# Important Safeguards

15. **Power Lines** — An outside antenna system should not be located in the vicinity of overhead power lines or other electric light or power circuits, or where it can fall into such power lines or circuits. When installing an outside antenna system, extreme care should be taken to keep from touching such power lines or circuits as contact with them might be fatal.
16. **Overloading** — Do not overload wall outlets and extension cords as this can result in a risk of fire or electric shock.
17. **Objects and Liquids** — Never push objects of any kind into this video unit through openings as they may touch dangerous voltage points or short out parts that could result in a fire or electric shock. Never spill liquid of any kind onto the video unit.
18. **Servicing** — Do not attempt to service this video unit yourself as opening or removing covers may expose you to dangerous voltage or other hazards. Refer all servicing to qualified service personnel.
19. **Damage Requiring Service** — Unplug this video unit from the wall outlet and refer servicing to qualified service personnel under the following conditions:
  - a. When the power-supply cord or plug is damaged.
  - b. If any liquid has been spilled into, or objects have fallen onto, the video unit.
  - c. If the video unit has been exposed to rain or water.
  - d. If the video unit does not operate normally by following the operating instructions. Adjust only those controls that are covered by the operating instructions, as an improper adjustment of other controls may result in damage and will often require extensive work by a qualified technician to restore the video unit to its normal operation.
  - e. If the video unit has been dropped or the cabinet has been damaged.
  - f. When the video unit exhibits a distinct change in performance — this indicates a need for service.
20. **Replacement Parts** — When replacement parts are required, be sure the service technician has used replacement parts specified by the manufacturer or have the same characteristics as the original part. Unauthorized substitutions may result in fire, electric shock or other hazards.
21. **Safety Check** — Upon completion of any service or repairs to this video unit, ask the service technician to perform safety checks to determine that the video unit is in safe operating order.

## Precautions

### USE & LOCATION

- **TO AVOID SHOCK HAZARD ...** Your Palmcorder and power supply should not be exposed to rain or moisture. Do not connect the power supply or operate your Palmcorder if it gets wet. Your Palmcorder has been designed for outdoor use, however it is not designed to sustain direct exposure to water, rain, sleet, snow, sand, dust, or direct splashing from a pool or even a cup of coffee. This action could permanently damage the internal parts of your Palmcorder. Do not attempt to disassemble this unit. There are no user serviceable parts inside. Unplug your Palmcorder from the power supply before cleaning.
- **DO NOT AIM YOUR PALMCORDER AT THE SUN OR OTHER BRIGHT OBJECTS**
- **DO NOT LEAVE THE PALMCORDER WITH THE EVF AIMED DIRECTLY AT THE SUN AS THIS MAY CAUSE DAMAGE TO THE INTERNAL PARTS OF THE EVF**
- **DO NOT EXPOSE YOUR PALMCORDER TO EXTENDED HIGH TEMPERATURE ...** Such as, direct sunlight, inside a closed car, next to a heater, etc... This action could permanently damage the internal parts of your Palmcorder.
- **AVOID SUDDEN CHANGES IN TEMPERATURE ...** If the unit is suddenly moved from a cold place to a warm place, moisture may form on the tape and inside the unit.
- **DO NOT LEAVE YOUR PALMCORDER OR THE POWER SUPPLY TURNED ON WHEN NOT IN USE.**
- **STORAGE OF YOUR PALMCORDER ...** Store and handle your Palmcorder in a manner that will not subject it to unnecessary movement (avoid shaking and striking). Your Palmcorder contains a sensitive pick-up device which could be damaged by improper handling or storage.

### CARE

- **TO CLEAN YOUR PALMCORDER ...** Do not use strong or abrasive detergents when cleaning your Palmcorder body.
- **TO PROTECT THE LENS ...** Do not touch the surface of the lens with your hand. Use a commercial Palmcorder lens solution and lens paper when cleaning the lens. Improper cleaning can scratch the lens coating.
- **TO PROTECT THE FINISH OF YOUR PALMCORDER ...** Before handling your Palmcorder, make sure your hands and face are free from any chemical products, such as suntan lotion, as it may damage the finish.

## **Getting Started**

Things You Should Know .....	2
Important Safeguards .....	3
Precautions .....	4
Before Using .....	6
Quick Guide .....	9
Supplying Power .....	11
Setting the Clock .....	13
Using the Palmcorder Menu .....	14
MENU OSD .....	15
Electronic Viewfinder/LCD Monitor Indications .....	19

## **Basic Operation**

Camera Recording .....	22
Remote Control (Optional) .....	26
Playback Your Recordings .....	27

## **Special Features**

Card Features .....	32
Dual Digital Electronic Image Stabilization System (D.E.I.S.) .....	39
Digital Zoom .....	40
Digital PhotoShot .....	41
Index Search .....	41
White Balance .....	42
Recording Still Pictures .....	42
Program AE .....	43
Other Digital Functions .....	44
Picture in Picture (PiP) .....	45
Strobe Multi Mode .....	46
Focus .....	47
Backlight .....	48
Audio/Video Fade In/Out .....	48
High Speed Shutter .....	49
Audio Dubbing using the Built-in Microphone .....	50
Memory-Stop Editing .....	51
Copying your Tapes to S-VHS or VHS Cassette .....	52
Copying from Digital Equipment (dubbing) .....	53
Transferring Your Images .....	54
Transferring Your Images (i.LINK) .....	58

## **For Your Information**

Palmcorder Accessory System .....	59
Palmcorder Accessory Order Form .....	61
Notes On Operations .....	62
Specifications .....	63
Before Requesting Service .....	64
Request for Service Notice .....	66
Index of Controls .....	67
Limited Warranty .....	71
Servicenter List .....	72
Spanish Quick Use Guide/Guía Para Uso Rápido .....	73
Index .....	75

# Before Using

## Unpack your Palmcorder

1 pc. AC Adaptor (PV-DAC11) with AC Cable and DC Cable

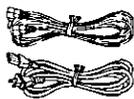
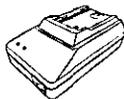

1 pc. A/V Cable (LSJA0280)



1 pc. Lens Cap (LSYF0478)



1 pc. CD-ROM of Driver Software for Windows 98/Me / Palmcorder USB Device Driver for Windows 98/Me/ CARD LINK (for USB) for Windows 98/Me (LSFT0265)



1 pc. Battery Pack (PV-DBP8A)



1 pc. 8 MB MultiMediaCard (LSFT0198A)



1 pc. USB Cable (LSJA0354)

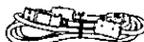

1 pc. Shoulder Strap (LSFC0013)



Microsoft® and Windows® are registered trademarks of Microsoft in the United States and other countries. Intel® Pentium® is a registered trademark. i.LINK and i are trademarks. IBM is a registered trademark of IBM Company. MultiMediaCard is a registered trademark. SD is a trademark.

## How to remove the Sensor tag

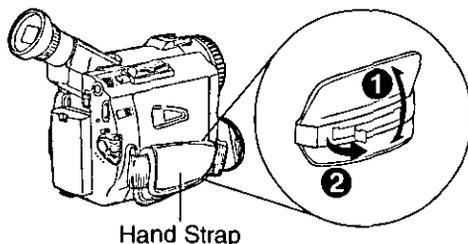

Hand Strap

- 1 Open the Hand Strap as illustrated at left.
- 2 Remove the Sensor tag. Then, replace the Hand Strap.

## Record Speed/Playback Time

Use only those tapes having the Mini DV logo indicating the 6.35 mm digital standard.

Cassette type	Record Speed/ Playback time	
	SP	LP
AY-DVM30EA	30 minutes	45 minutes
AY-DVM60EA	60 minutes	90 minutes
AY-DVM80EA	80 minutes	120 minutes

## Erase Protection

Cassettes have a sliding record tab to ensure recordings are not accidentally erased.

- 1 To prevent accidental erasure:  
Slide the tab to the left (open).



- 2 To record again:  
Slide the tab to the right (close).



## Cassette Insertion/Removal

- If the Palmcorder is connected to a power source, the cassette can be inserted and ejected without turning the Palmcorder on.

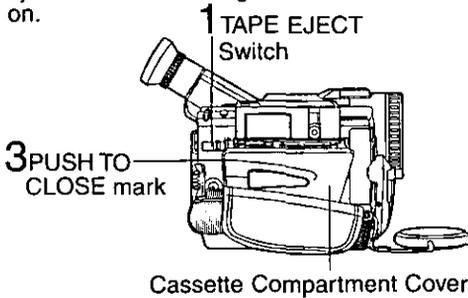

## Before you begin

- Connect the Palmcorder to a power source. (See pages 11, 12.)

- 1 Slide **TAPE EJECT** to open the Cassette Compartment Cover.
- 2 Insert a cassette record tab up, window side facing out.
- 3 Press **PUSH TO CLOSE** mark to close the Cassette Compartment Cover.

- **To remove the cassette...**  
Slide **TAPE EJECT** to open the Cassette Compartment Cover and pull the cassette tape straight out.

## Hint to locate recording position when inserting cassette

- When you insert a partially recorded cassette, use the Edit Search Function (see page 24) to visually confirm the point at which you want to start a new recording. Especially advisable when you want to add a recording to a tape that is already full.

## Note

- If hand strap is tight it may prevent Cassette Compartment Cover from fully opening for tape insertion or ejection. Loosen hand strap if necessary.
- When inserting the cassette, make sure it faces in the right direction and then push in completely.

## Using the Light (Optional)

To brighten the natural colors in a scene.

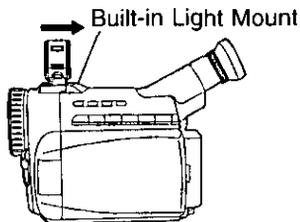

## Note

- Using the light will reduce battery operating time.
- Be sure to provide adequate ventilation if using Light in a hot environment for an extended period.
- Be sure **LIGHT** is set to **OFF** when not in use.
- Do not attempt to lift or carry the Palmcorder by holding the Enhancement Light.
- If light bulb needs to be replaced, take Light to your nearest authorized servicerenter.

## Before you begin

- Connect the Palmcorder to a power source. (See pages 11, 12.)
- Set **POWER** to **CAMERA** or **M-CARD**.

- 1 Slide Light into the Built-in Light Mount.

Be sure it locks into place.

- 2 Press **LIGHT** to turn **ON** or **OFF**.

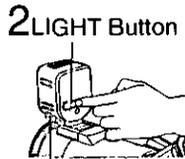

LIGHT RELEASE Button

## To remove the Light:

Press **LIGHT RELEASE** and slide the Light out of the mount.

## Caution

This light becomes hot during operation. Make sure nothing covers the Light during operation.

# Before Using

## Attaching the Shoulder Strap

- 1 Undo the two strap ends from their buckles.
- 2 Remove the buckle from one end of the strap.
- 3 Thread the strap (with no buckle) through the Light Holder so that it faces outward. Then, reinsert the buckle.

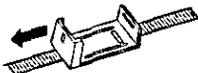
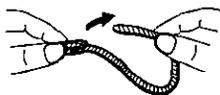

## Adjust the Length

- 1 Loosen the strap from the Buckle and create a loop.
- 2 Pull the strap firmly through the Buckle to shorten or lengthen the strap.

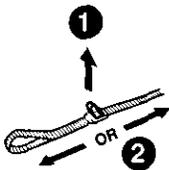

## Attach the Light (Optional)

- 1 Insert the Light into the Light Holder for Storage.
- 2 To remove the Light, press **LIGHT RELEASE** and slide Light out of the holder.

LIGHT RELEASE  
Button

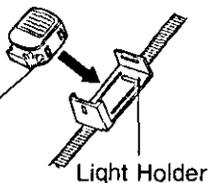

- 4 Thread the strap ends through the Strap Attachment Rings.

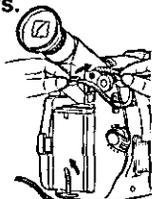

- 5 Reinsert the strap ends through their buckles.
  - Make sure the straps are not twisted.

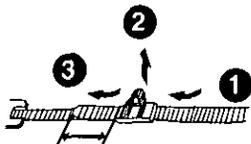

## Hand Strap

Adjust the length of the Hand Strap to the size of your hand as illustrated.

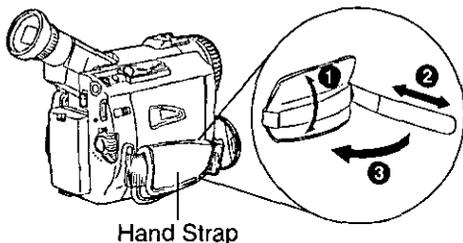

Hand Strap

## Lens Cap

### Attaching the Lens Cap Cord to the Hand Strap

Remove the Hand Strap from the front clasp and thread the Strap through the loop in the Lens Cap Cord. Reattach the Hand Strap.

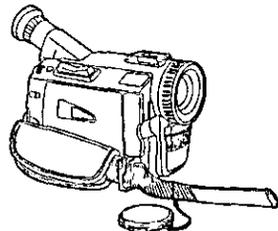

## Insert the Battery Pack

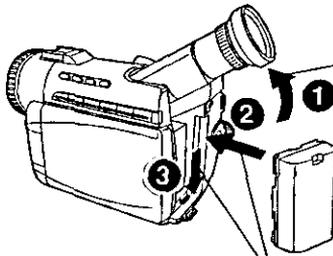

### Before you begin

- Charge the Battery. (See page 11.)

**1** Tilt Viewfinder upward.

**2** Insert the Battery Pack and slide it down until it locks with a click.

## Insert Cassette

**1** Set POWER Switch to VCR or CAMERA.

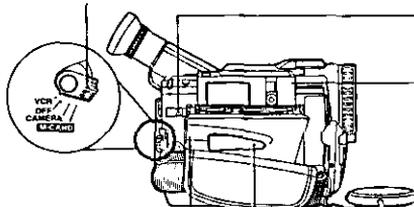

**2** Slide TAPE EJECT Switch to open the Cassette Compartment Cover.

**3** Insert a cassette record tab up, window side facing out.  
• Make sure the record tab is closed. (See page 6.)

**4** Press PUSH TO CLOSE mark to close the Cassette Compartment Cover.

### Protection Film Note

- Remove the Protection Film before use.

## Camera Recording

When the LCD monitor is fully open, the Viewfinder automatically turns OFF.

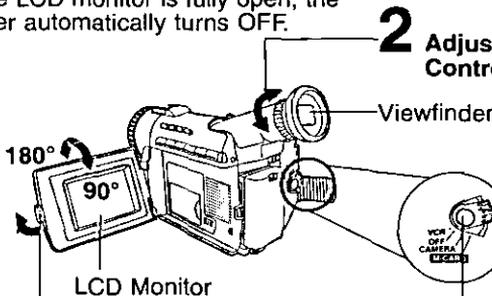

**2** Adjust the Vision Adjustment Control to your eyesight.

**1** Set POWER Switch to CAMERA.

**3** Press LCD-OPEN Button to unlock the LCD monitor. Swing it fully open and adjust the angle.

**4** Press REC/PAUSE Button to start recording. Press REC/PAUSE Button again to pause recording.

# Quick Guide

## Insert Memory Card\*

## Before you begin

- Charge the Battery. (See page 11.)

\*Memory Card: MultiMediaCard or SD Memory Card (See page 60.)

- Be sure to insert the Memory Card before using the Card PhotoShot. (See page 32.)

Below is a list of memory cards which can be used in this Palmcorder.

Memory Card	Capacity
MultiMediaCard (LSFT0198A) (supplied)	8 MB
MultiMediaCard (SanDisk brand)	8 MB, 16 MB
SD Memory Card (optional) (See page 59.)	16 MB, 32 MB, 64 MB

## SD Memory Card write protection switch



A write protection switch is located on the SD Memory Card. Sliding the switch to the "LOCK" position prevents writing on or formatting the card.

Write protection switch

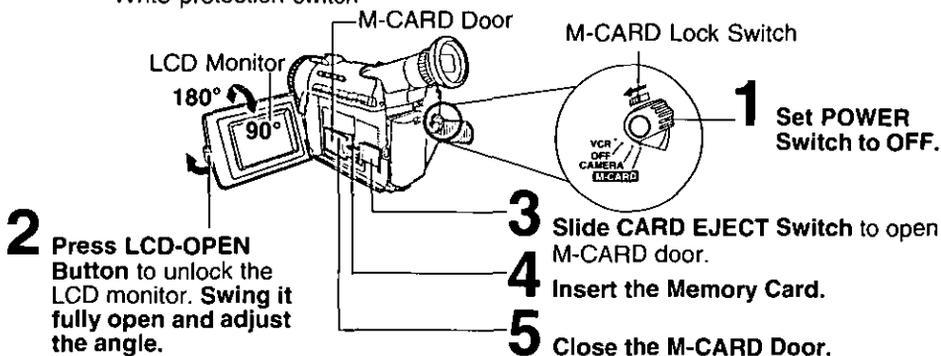

## To Watch Playback in the LCD (Liquid Crystal Display)

## Before you begin

- Charge the Battery. (See page 11.)

When the LCD monitor is fully open, the Viewfinder automatically turns OFF.

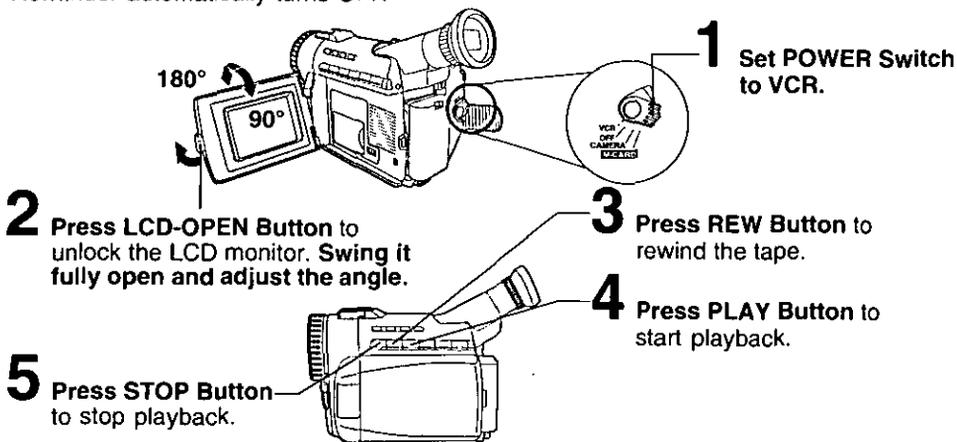

## Charge the Battery Pack on the AC Adaptor

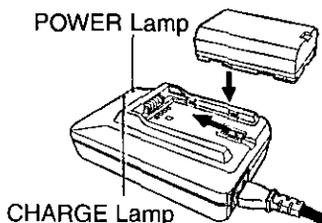
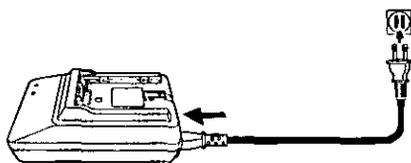

- 1** Connect and plug in the Power Cord as shown.
  - POWER Lamp will light.
  - Remove the DC Cable, if attached, from the adaptor.
- 2** Attach the Battery as shown to charge.
  - CHARGE Lamp lights up. It goes out when charging is complete (approx. 1 hour). Expect approx. 1 hour 30 minutes of operation (EVF usage) when fully charged.
- 3** Remove the Battery. Slide the Battery out and then lift up.

### Note

#### About the Flashing of the CHARGE Lamp

- Charge the Battery within an ambient temperature range of 10 °C and 30 °C.
- If charging is done in extreme low or high temperatures, Battery charge time increases.

#### CHARGE Lamp flashes when...

- The Battery is being charged, but charging is taking longer than normal.
- Charging is not possible. Remove the Battery once, wait a short time, then re-attach it for charging.

## Insert the Battery Pack

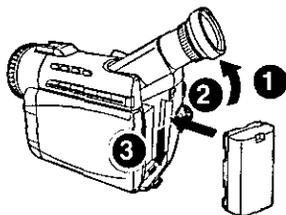

- 1** Tilt Viewfinder upward.
- 2** Insert the Battery Pack and slide it down until it locks with a click.

## Remove the Battery Pack

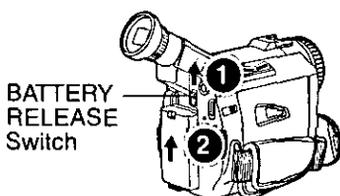

- To remove the Battery Pack:**  
Slide the Battery upward while sliding the BATTERY RELEASE Switch.

# Supplying Power

## Battery Care

### Caution:

- Charge only with specified charger.
- Charge the Battery within an ambient temperature range of 32° F (0° C) and 104° F (40° C).
- The Battery may be warm after charging or just after use. This is normal.
- Do not use an insufficiently charged or worn out Battery.
- If charging is done in extreme low or high temperatures, Battery charge time increases.

### Safety precautions:

- Do not get the Battery near, or dispose of in fire.
- Do not directly connect (short circuit) the positive (+) and negative (-) terminals.
- Never attempt to disassemble or reassemble the Battery.

## Use AC Adaptor

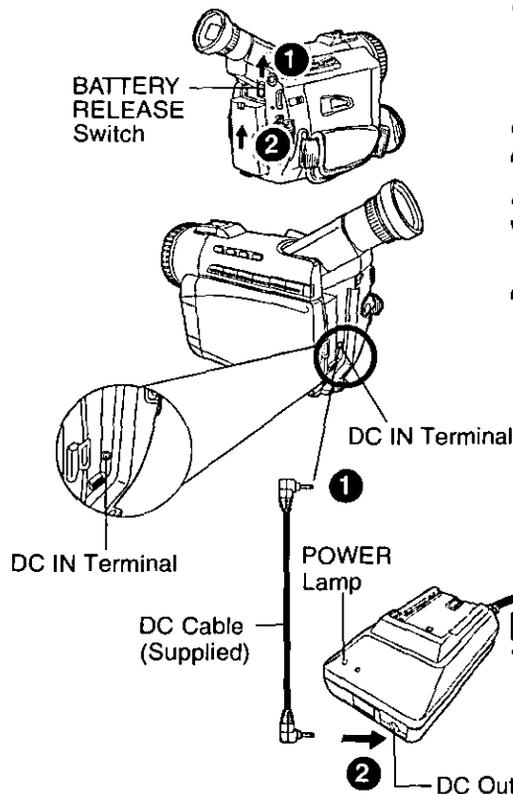

### To avoid damage to the Battery:

- Do not drop or jar the Battery.
- Use the Battery with specified models only.
- If the Battery is used in extremely high temperatures, a safety device will automatically prevent operation.

### To insure longer battery life:

- While not in use, remove Battery from the Palmcorder and AC Adaptor and store in a cool, dark, dry place. If you leave the Battery in the Palmcorder or on the AC Adaptor, the Battery will no longer be rechargeable.
- Keep the Battery terminals clean.

- 1** Slide the Battery upward while sliding the BATTERY RELEASE Switch to remove the Battery Pack. (See page 11.)
- 2** Insert the DC Cable into the DC IN Terminal.
- 3** Connect the other end of the DC Cable to the AC Adaptor as shown.
- 4** Plug in the AC Adaptor.
  - The POWER Lamp on the AC Adaptor lights up.

### Note

- When not in use, unplug the AC Adaptor from the AC outlet. (AC Adaptor consumes 1 W of electric power when plugged into an AC outlet even when not in use.)

## Set the Date and Time

The date and time is calculated, including leap year, up to DEC 31 2089.

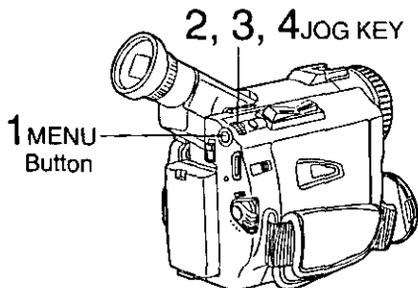

### EXAMPLE:

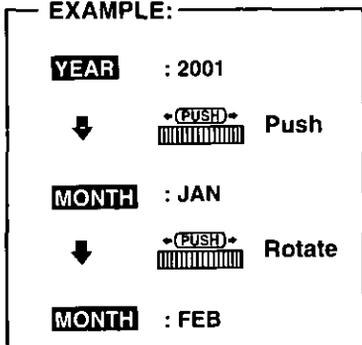

### Note

- To make corrections, Press JOG KEY repeatedly to move back to an item and correct.
- A built-in Battery maintains clock operation. If the Palmcorder is not connected to a power source for a few months, the built-in battery may discharge and "CLOCK BATTERY" indication appears. (See page 21.)

## Before you begin

- Connect the Palmcorder to a power source. (See pages 11, 12).
- Set POWER to CAMERA or VCR.

- 1 Press **MENU** to display the Camera or VCR mode menu screen. (See page 14.)

### [ CAMERA MENU ] [ VCR MENU ]



- 2 Rotate **JOG KEY** to select **DISPLAY SETTING**, and then press **JOG KEY** to display the DISPLAY SETTING menu screen.
- 3 Rotate **JOG KEY** to select **CLOCK SET**, and then press **JOG KEY** to set to ON. (See pages 16, 18.)
  - The DATE/TIME SETTING menu is displayed.
- 4 Rotate **JOG KEY** to select YEAR, then press **JOG KEY** to fix and move to the next item. Likewise, set the month, day, hour, and minutes.



When DATE/TIME setting is completed, press **MENU** three times to start the clock and exit.

# Using the Palmcorder Menu

The Palmcorder features three menu displays: one for CAMERA mode (recording), one for M-CARD (Memory Card Photo Mode) and the other for VCR mode (Playback). (See pages 15-18.)

- While the Menu screen is displayed, you cannot record on or play a tape.
- While recording, the Menu screen cannot be displayed.
- During playback, the Menu screen can be displayed.

## Before you begin

- Connect the Palmcorder to a power source. (See pages 11, 12.)
- Set POWER to CAMERA or VCR.

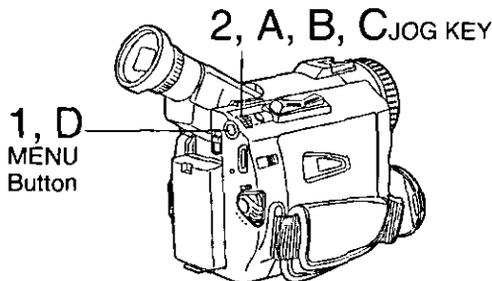

## Displaying the MENU

- 1** Press **MENU** to display the CAMERA or VCR menu (according to the POWER setting).
- 2** Rotate **JOG KEY** to select a menu item.

## Setting the MENU Items (EX. VCR Mode menu)

- A** Press **JOG KEY** to set your selection.
- B** Rotate **JOG KEY** to select a menu item.
- C** Press **JOG KEY** to set your selection.
  - The "●" mark indicates selection.
- D** Press **MENU** twice to exit the menu.

VCR PLAY FUNCTION		
D.FUNCTION	OFF	MIRROR
STROBE	MOZAIC	
SLIM	TRAIL	
STRETCH		
D.EFFECT	OFF	SEPIA
	MONO	
●SELECT: ROTATE JOG KEY		
*SET : PUSH JOG KEY		
*EXIT : PUSH MENU KEY		

VCR PLAY FUNCTION		
D.FUNCTION	OFF	MIRROR
STROBE	MOZAIC	
SLIM	TRAIL	
STRETCH		
D.EFFECT	OFF	SEPIA
	MONO	
●SELECT: ROTATE JOG KEY		
*SET : PUSH JOG KEY		
*EXIT : PUSH MENU KEY		

## CAMERA Main menu

- 1 : D. FUNCTION**  
CAMERA FUNCTION menu is displayed. To select one of the 10 digital functions (MIRROR, STROBE, MOZAIC, SLIM, TRAIL, STRETCH, GAIN-UP, WIPE, MIX, PinP).
- 2 : ADJUST**  
CAMERA ADJUST menu is displayed. To select PROG. AE, W. BALANCE, or H.S.S. (High Speed Shutter).
- 3 : REC MODE**  
CAMERA REC-MODE menu is displayed. To select REC-SPEED, AUDIO-REC, INDEX, SHUTTER, SELF-REC, or WIND-CUT.
- 4 : SET-UP**  
CAMERA SET-UP menu is displayed. To select REMOTE or BEEP.
- 5 : DISPLAY SETTING**  
DISPLAY SETTING menu is displayed. To select DISPLAY, C.RESET, DATE/TIME, or CLOCK-SET.
- 6 : LCD/EVF SETTING**  
LCD/EVF SETTING menu is displayed. To select LCD BRIGHTNESS, LCD COLOR or EVF BRIGHTNESS.
- 7 : PHOTO TITLE**  
PHOTO TITLE menu is displayed. To select TITLE or MODE.

## VCR Main menu

- 1 : PLAY FUNCTION**  
VCR PLAY FUNCTION menu is displayed. To select D. FUNCTION or D.EFFECT.
- 2 : REC MODE**  
VCR REC MODE menu is displayed. To select REC-SPEED.
- 3 : PLAY MODE**  
VCR PLAY MODE menu is displayed. To select INDEX, AUDIO, REMOTE, or B.SEARCH.
- 4 : MULTI SETTING**  
MULTI SETTING menu is displayed. To select SPEED.
- 5 : DISPLAY SETTING**  
DISPLAY SETTING menu is displayed. To select DISPLAY, C.RESET, DATE/TIME, or CLOCK-SET.
- 6 : LCD/EVF SETTING**  
LCD/EVF SETTING menu is displayed. To select LCD BRIGHTNESS, LCD COLOR or EVF BRIGHTNESS.

## Camera Mode Menu Screen

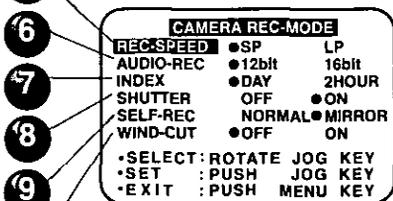
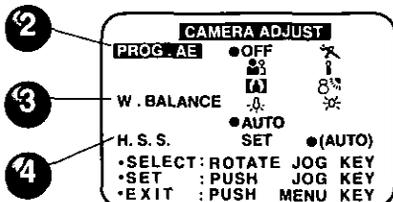
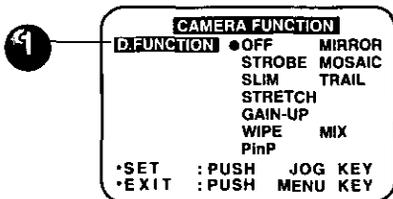

- 1 **DIGITAL FUNCTION** (See page 44.)  
To select one of the 10 digital functions.  
Setting to OFF cancels the previously selected digital function.
- 2 **PROG. AE** (See page 43.)  
To select one of the 5 Program AE modes. Setting to OFF cancels the previously selected Program AE mode.
- 3 **W. BALANCE** (See page 42.)  
To select one of the 3 White Balance modes.
- 4 **H. S. S. (High Speed Shutter)** (See page 49.)  
To select a desired shutter speed.
- 5 **REC-SPEED** (See page 6.)  
**SP:** Normal recording speed mode.  
**LP:** Recording time is 1.5 times as long as in the SP mode. For example, 120 minutes of recording is possible on a 80 minute tape.
- 6 **AUDIO-REC** (See page 50.)  
**12 bit:** The sound is recorded in the 12 bit/32 kHz mode.  
**16 bit:** The sound is recorded in the 16 bit/48 kHz high-quality mode.
- 7 **INDEX** (See page 30.)  
**DAY:** An index signal is recorded when recording is restarted after the date has changed since the last recording.  
**2 HOUR:** An index signal is recorded when recording is restarted after a lapse of more than 2 hours.
- 8 **SHUTTER** (See page 41.)  
When set to ON, still pictures taken in the PhotoShot mode are recorded with a visual shutter effect and click sound.
- 9 **SELF-REC** (See page 23.)  
**NORMAL:** During self-recording, the picture on the LCD Monitor is the same as it will be recorded.  
**MIRROR:** During self-recording, the picture on the LCD Monitor is horizontally reversed.
- 10 **WIND-CUT** (See page 22.)  
To reduce sound distortion caused by wind hitting the microphone. However, this slightly deteriorates the sound reproduction in the bass range.

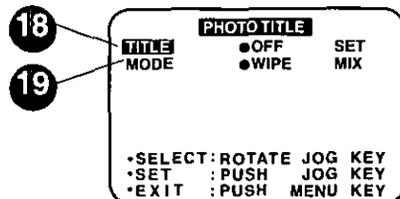
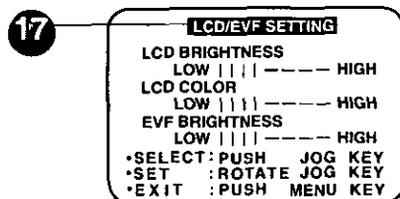
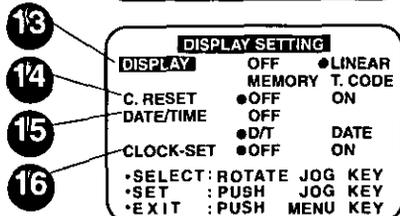
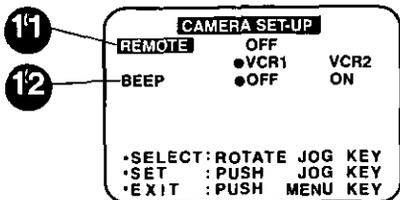

- 11** **REMOTE** (See page 26.)  
**VCR1:** To receive signals from the Remote Control, set to VCR1.  
**VCR2:** To receive signals from the Remote Control, set to VCR2.  
**OFF:** To prevent reception of signals from the Remote Control.

- 12** **BEEP**  
 Set to ON to hear beep when starting and stopping camera recording or when unusual conditions occur. To cancel the beep, set to OFF.  
 Palmcorder will beep:  
 Once when you start recording  
 Twice when you stop recording  
 Repeatedly when warning of unusual conditions.  
 (See page 21.)

- 13** **DISPLAY** (See page 19.)  
 To select the desired type of display and counter indication displayed on the LCD Monitor or in the viewfinder.

- 14** **C.RESET** (See page 19.)  
 Setting to ON resets the counter to zero.

- 15** **DATE/TIME** (See page 20.)  
 The date and time can be set and displayed on the screen.

- 16** **CLOCK-SET** (See page 13.)  
 When set to ON, the date and time can be set on the screen.

- 17** **LCD/EVF SETTING** (See page 23.)  
 Setting to ON displays the menu for adjusting the LCD brightness, color level, and the EVF brightness.

- 18** **TITLE** (See page 38.)  
 Photo Title is recorded.

- 19** **MODE** (See page 38.)  
 To select one of the 2 Photo Title modes.

## VCR Mode Menu Screen

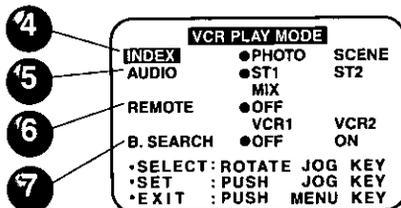
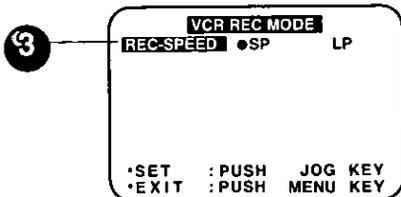
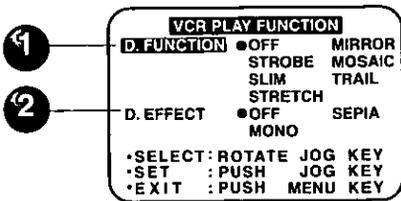

**1 DIGITAL FUNCTION** (See page 44.)  
 To select one of the 6 digital functions. Setting to OFF cancels the previously selected digital function.

**2 D. EFFECT** (See page 44.)  
 To select one of the 2 digital picture effects for playback. Setting to OFF cancels the previously selected digital effect.

**3 REC-SPEED** (See page 6.)  
**SP:** Normal recording speed mode.  
**LP:** Recording time is 1.5 times as long as in the SP mode. For example, 120 minutes of recording is possible on an 80 minute tape.

**4 INDEX** (See page 30.)  
 To select the desired Index Search function.

**PHOTO:** To search for Photo shot pictures.

**SCENE:** To search for scenes marked with Index signal.

**5 AUDIO** (See page 51.)  
 To select the desired audio playback mode after performing audio dubbing in the 12 bit mode (SP mode only).

**ST1 :** The original sound alone is played back.

**ST2 :** The dubbed sound alone is played back.

**MIX :** The original sound and the dubbed sound are played back together.

**6 REMOTE** (See page 26.)  
**VCR1 :** To receive signals from the Remote Control, set to VCR1.  
**VCR2:** To receive signals from the Remote Control, set to VCR2.  
**OFF :** To prevent reception of signals from the Remote Control.

**7 B. SEARCH (Blank Search)**  
 (See page 25.)  
 Select ON to go directly to a blank portion of the tape.

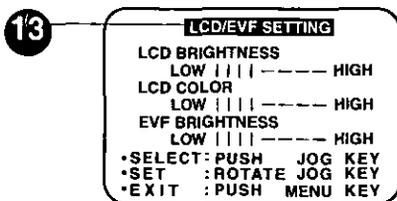
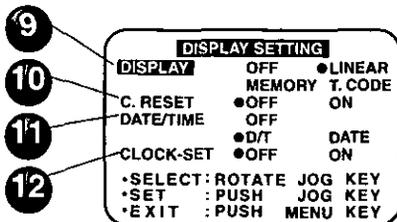
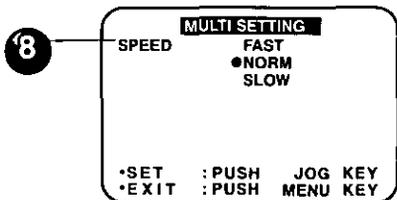

**8** **SPEED** (See page 46.)  
 In Strobe Multi mode, used to select the interval at which a succession of still screens are captured from the playback picture.

**FAST** : Every 0.3 seconds

**NORM** : Every 0.6 seconds

**SLOW** : Every 1.0 seconds

**9** **DISPLAY** (See page 19.)  
 To select the desired type of display and counter indication displayed on the LCD Monitor or in the viewfinder.

**10** **C.RESET** (See page 19.)  
 Setting to ON resets the counter to zero.

**11** **DATE/TIME** (See page 19.)  
 The date and time can be set and displayed on the screen.

**12** **CLOCK-SET** (See page 13.)  
 When set to ON, the date and time can be set on the screen.

**13** **LCD/EVF SETTING** (See page 23.)  
 Setting to ON displays the menu for adjusting the LCD brightness, color level, and the EVF brightness.

## M-CARD Menu Screen

[ Photo Rec Mode Menu Screen ]

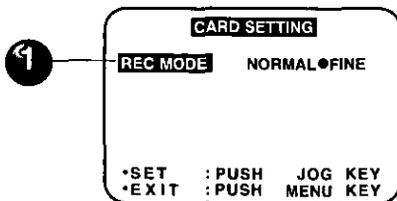

**1** **REC MODE** (See page 32.)  
 To select Photo Rec Mode.

**2** **DISPLAY** (See page 34.)  
 Select to OFF to cancel all Displays on the screen.

**3** **DCF** (See page 34.)  
 Select to OFF to cancel DCF No. on the screen.

[ Photo Play Mode Menu Screen ]

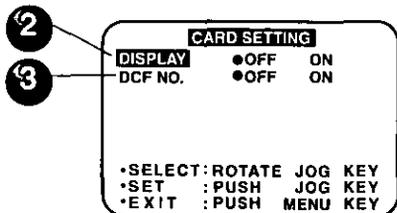

# Electronic Viewfinder/LCD Monitor Indications

Here are some of the basic indications which will appear on the Palmcorder EVF and LCD Monitor. Only Date and Time indications will be recorded onto the tape.

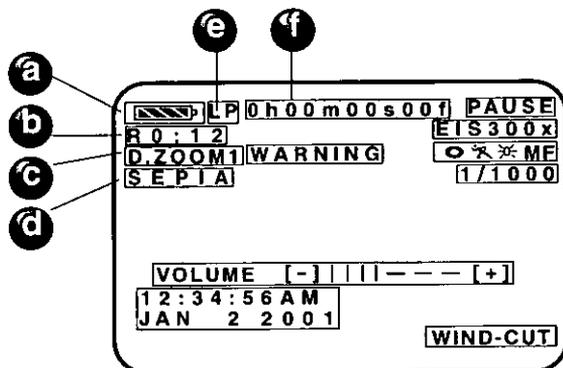

## a Battery Remaining

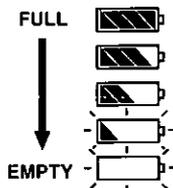

## b Tape Remaining

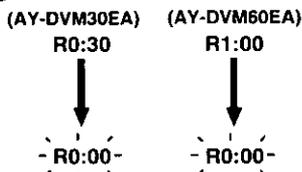

- It will take several seconds for the tape remaining indicator to operate after the tape starts moving.

## c Digital Zoom and other Digital Functions (See page 40.)

This display appears when the digital zoom function has been activated.

## d Playback Effect (See page 44.)

This display appears when SEPIA or MONO is selected in VCR menu.

## e Tape Speed Indication (See page 15.)

Indicates the tape speed (SP or LP).

## f Display ON/OFF and Counter/Time Code

The indication switches as shown below when the desired "DISPLAY" mode is selected from the menu. (See pages 16, 18.)

- When OFF is selected, all displays are turned off.

### Linear Time Counter Memory Counter

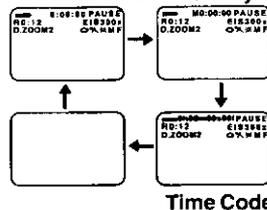

### Memory Counter M 0:00:00

The Palmcorder will stop whenever it reaches the point where the counter was previously set to M 0:00:00 during audio dub, fast forward, or rewind.

### Time Code 0h00m00s00f

The Palmcorder calculates and displays exactly where you are on any tape in terms of hours, minutes, seconds, and frames (30 frames = 1 second).

- This display can not be reset.

### IMPORTANT NOTE:

- Display must be set to ON for MF, AE, W.BALANCE or BACK LIGHT indications to be displayed on the EVF or LCD Panel when selected.
- C.RESET does not work when DISPLAY is set to OFF and T.CODE.

# Electronic Viewfinder/LCD Monitor Indications

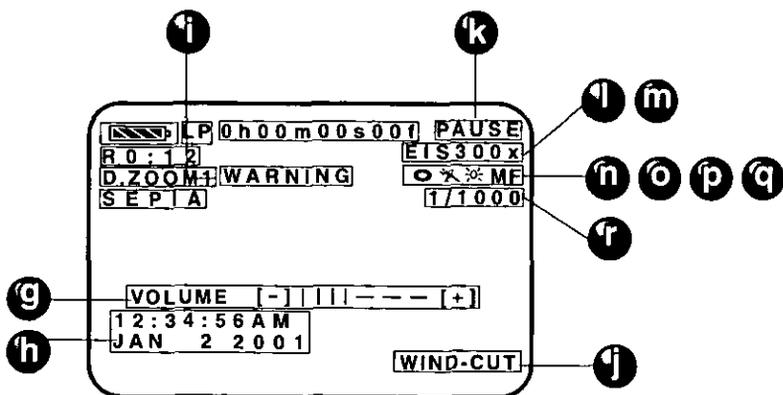

**g** **Volume Display** (See page 27.)  
The volume bar appears when the volume of the built-in speaker is being adjusted.

**h** **Date and Time Indication**  
(See pages 16, 18.)

As shown below, the date and time indication changes each time DATE/TIME is selected from the Palmcorder's MENU (see pages 16, 18) or the DATE/TIME Button is pressed on the remote (optional).

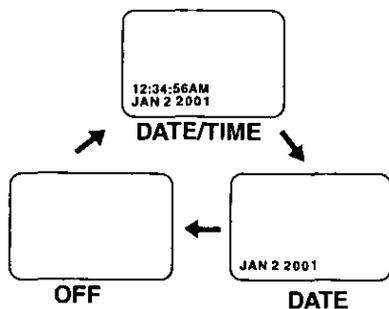

**i** **WARNING indication**  
(See page 21.)  
The warning displays appear in the EVF and the LCD monitor.

**j** **WIND-CUT indication**  
(See page 15.)

**k** **Tape Mode Indications**

<b>REC</b>	Recording.
<b>PHOTO</b>	PhotoShot recording.
<b>PAUSE</b>	Paused during recording.
<b>PLAY</b>	Playback.
<b>R ▷</b>	Repeat Playback.
<b>CHK</b>	Recording Check.
<b>FF</b>	Fast forward.
<b>REW</b>	Rewind.
<b>▷▷</b>	FF Search.
<b>◁◁</b>	REW Search.
<b>BLANK</b>	Blank Search.
<b>SEARCH</b>	Index Search.

**l** **Digital EIS Indications**  
(See page 39.)

**m** **Zoom Magnification Level**  
(See page 40.)

**n** **Manual Focus Indication**  
(See page 47.)

**o** **White Balance Indication**  
(See page 42.)

**p** **PROGRAM-AE Indication**  
(See page 43.)

**q** **Backlight Indication**  
(See page 48.)

**r** **Shutter Mode indication**  
(See page 49.)

# Electronic Viewfinder/LCD Monitor Indications

The following warning displays appear in the EVF and the LCD monitor.

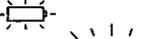
Indications	Condition
 <b>TAPE NOT INSERTED</b>	If the Palmcorder is in CAMERA mode without a cassette inserted, "Q.D" will flash and "TAPE NOT INSERTED" will appear for 5 seconds. Recording will not start.
 <b>CHECK REC TAB</b>	If the Palmcorder is in CAMERA mode with the cassette sliding record tab opened, "Q.D" will flash and "CHECK REC TAB" will appear for 5 seconds. Recording will not start.
 <b>CANNOT REC</b>	When Audio dub is performed and the sliding record tab is open, or a blank portion of tape is detected, "Q.D" will flash and "CANNOT REC" will appear for 5 seconds.
 <b>TAPE END</b>	When the tape is about to end in REC mode, "Q.D" END" will flash and "TAPE END" will appear for 5 seconds.
<b>INCOMPATIBLE TAPE</b>	When an incompatible tape is detected, "INCOMPATIBLE TAPE" will appear for 5 seconds.
<b>NEED HEAD CLEANING</b>	If the video heads require cleaning, "NEED HEAD CLEANING" will appear for 5 seconds.
<b>REMOTE</b>	When the Palmcorder and remote are not set to the same mode (VCR1 or VCR2), "CHECK REMOTE MODE" appears for 5 seconds. Also appears when the Palmcorder is first turned on.
<b>CANNOT REC LP-MODE</b>	When an AUDIO DUB is attempted on a pre-recorded LP tape, "CANNOT REC LP-MODE" will appear for 5 seconds.
 <b>DEW DETECTED</b>	If excessive moisture condenses in the unit, "WARNING" will flash, "DEW DETECTED" will appear, and the Palmcorder will automatically turn OFF in 15 seconds. In this case, wait until the indicator no longer flashes when your Palmcorder is turned ON again.
 <b>LOW BATTERY</b>	When a battery recharge is necessary, "WARNING" will flash, "LOW BATTERY" will appear, and the Palmcorder will automatically turn OFF in 15 seconds. (See page 19.)
<b>CLOCK BATTERY</b>	When the built-in lithium clock battery is discharged, "CLOCK BATTERY" will appear. To re-charge the lithium clock battery, connect the AC Adaptor to the Palmcorder. Recharging takes approx. 4 hours. Reset the clock after charging.
<b>INCOMPATIBLE DATA</b>	If you play tape recorded in a format other than NTSC or you try to copy a copy-protected data. "INCOMPATIBLE DATA" will appear.
<b>NO SPACE LEFT</b>	When a still image is transferred from a tape to an already full Memory Card, "NO SPACE LEFT" appears.
<b>DISCONNECT DV CABLE</b>	If the Palmcorder is in M-CARD mode or Photo Title (CAMERA mode) and the DV Interface Cable (i.LINK) is connected, "DISCONNECT DV CABLE" appears. In this case, remove the DV Interface Cable (i.LINK) from the Palmcorder.

# Camera Recording

## Simple Recording

Remove the lens cap and clip it to the hand strap.

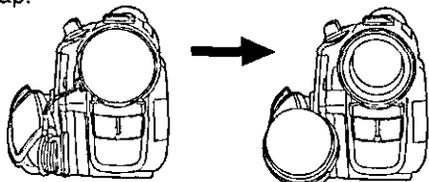

↑  
Clip here

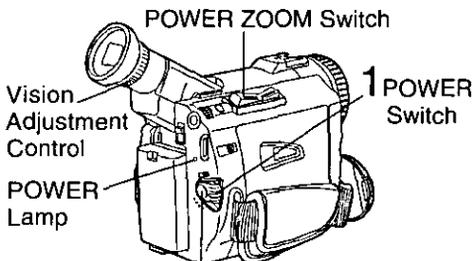

3 REC/PAUSE Button

## WARNING:

- Do not leave the Palmcorder with the EVF aimed directly at the sun as this may cause damage to the internal parts of the EVF.
- Do not lift, or carry, the Palmcorder by the EVF or the LCD Monitor.

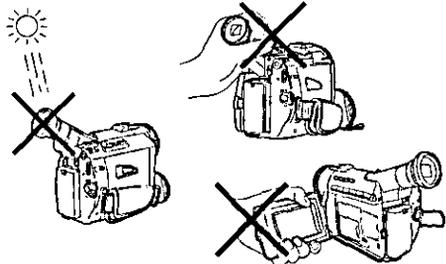

## Zoom

You can gradually zoom in for close ups or zoom out for wide angle shots.

**Zoom slowly** : by lightly pressing the "T" (Telephoto) or the "W" (Wide Angle) side of the POWER ZOOM Switch.

**Zoom quickly** : by applying more pressure.

## Note

- The zooming speed ranges from a slow 22 seconds to a fast 2 seconds according to the amount of pressure applied to the POWER ZOOM Switch.

22

For assistance, please call : 1-800-211-PANA(7262) or  
send e-mail to : consumerproducts@panasonic.com

## Before you begin

- Connect the Palmcorder to a power source. (See pages 11, 12.)
- Insert a cassette with record tab closed. (See page 6.)

1

Set **POWER** to **CAMERA**.

- The **POWER** Lamp lights red.
- Be sure **POWER** is fully turned to **CAMERA** position.

**EVF**



REC/PAUSE mode

2

With the **Viewfinder Eye Cup** up to your eye, adjust the **Vision Adjustment Control** to your eyesight. (See page 9.)

3

Press **REC/PAUSE** to start recording.

- "REC" is displayed on the screen.
- Press **REC/PAUSE** again to pause recording.
- To reduce microphone wind noise, set the **WIND-CUT** to **ON**. (See **WIND-CUT** on page 15.)

- When the Palmcorder is aimed at excessively bright objects, or bright lights, a vertical bar may appear in the picture. This is a normal characteristic of the CCD pick-up device. Try to avoid this whenever possible.

## To conserve power

After 5 minutes, the Record/Pause mode will automatically change to Standby mode. To resume recording, set **POWER** to **OFF** and then **ON** again.

## Using the LCD Monitor

The LCD (Liquid Crystal Display) monitor can be used while recording.

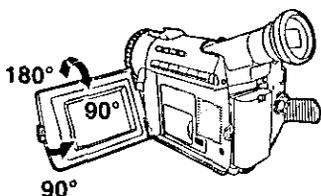
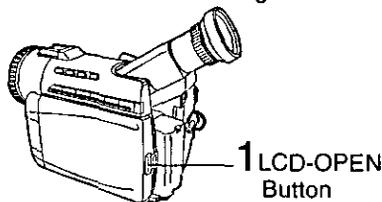

## To adjust the LCD BRIGHTNESS or COLOR

**A** Press **MENU** to display the main menu screen.

**B** Rotate **JOG KEY** to select **LCD/EVF SETTING** from the main menu screen. (See pages 16, 18.)

**C** Press **JOG KEY** to display the LCD/EVF SETTING screen.

**D** Press **JOG KEY** to select LCD BRIGHTNESS or LCD COLOR, then rotate **JOG KEY** to adjust.

**E** Press **MENU** twice to exit this mode.

## Self Recording

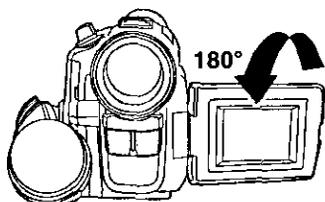

## Before you begin

- Connect the Palmcorder to a power source. (See pages 11, 12.)
- Insert a cassette with record tab closed. (See page 6.)

**1** Press **LCD-OPEN** to unlock the LCD monitor.

**2** Swing the LCD monitor fully open and adjust the viewing angle.

- The LCD monitor will automatically turn on.
- When the LCD monitor is completely closed, it will shut off automatically to save power.
- Adjust the LCD Brightness and/or color of the LCD monitor if necessary. Please refer to "To adjust the LCD BRIGHTNESS or COLOR" below.

**3** Start recording. (See page 22.)

### Note

- Using the LCD monitor will reduce battery operating time.
- Close the LCD monitor completely when not in use.

LCD/EVF SETTING	
LCD BRIGHTNESS	LOW      ----HIGH
LCD COLOR	LOW      ----HIGH
EVF BRIGHTNESS	LOW      ----HIGH
*SELECT: PUSH JOG KEY	
*SET : ROTATE JOG KEY	
*EXIT : PUSH MENU KEY	

Rotate the LCD monitor 180 degrees so it faces the same direction as the lens to record yourself (CAMERA mode). The picture in the LCD monitor will appear reversed.

Set **SELF-REC** to MIRROR (see page 15) in the Camera mode menu screen to see the picture as it is actually being recorded.

# Camera Recording

## Recording Check

To playback the final few seconds of the last recorded scene in the REC/PAUSE mode.

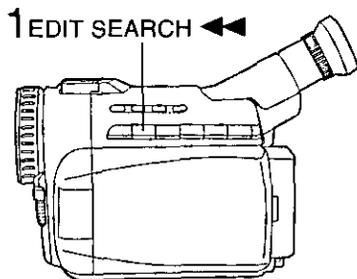

- 1 Press **EDIT SEARCH** ◀◀ briefly in the REC/PAUSE mode.

The [CHK] indication appears. After checking, the Palmcorder returns to the REC/PAUSE mode.

- For Recording Check, the Palmcorder must be in the same mode (SP or LP) as was used for recording, otherwise the playback picture is distorted.



## Edit Search

You can visually search for scenes in CAMERA mode to maintain proper continuity when taping.

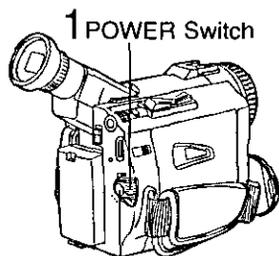

2, 3 REC/PAUSE Button

- 1 Set **POWER** to **CAMERA**.
  - The **POWER** Lamp lights red.
  - Be sure **POWER** is fully turned to **CAMERA** position.
- 2 In **REC/PAUSE** mode, hold down **EDIT SEARCH** ▶▶ to perform a forward visual search or **EDIT SEARCH** ◀◀ to perform a reverse visual search. Releasing the button stops the search.
- 3 Press **REC/PAUSE** to continue recording.

### Note

- During Edit Search, the picture will become mosaic in both ◀◀ and ▶▶ search, the sound will be muted in reverse visual search.
- Make sure the SP/LP tape speed setting is the same as the recording to eliminate distortion during edit search.

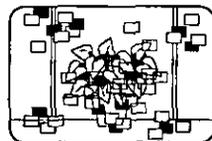
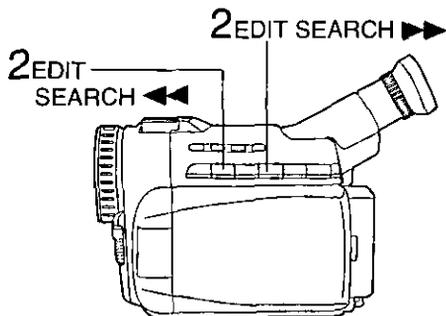

## Blank Search

You can go directly to a blank portion of tape and start recording exactly where you left off.

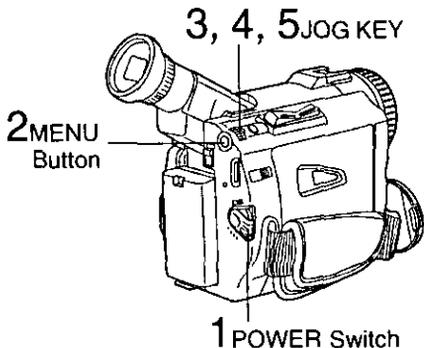

- 1** Set the **POWER** to **VCR**.
  - The **POWER** Lamp lights red.
  - Be sure **POWER** is fully turned to **VCR** position.
- 2** Press **MENU** to display the **VCR** mode menu screen.
- 3** Rotate **JOG KEY** to select **PLAY MODE**, then press **JOG KEY** to display the **VCR PLAY MODE** menu screen.
- 4** Rotate **JOG KEY** to select **B.SEARCH** in the **VCR PLAY MODE** menu. (See page 17.)
- 5** Press **JOG KEY** to select **ON**.
  - "BLANK" will appear on the screen.

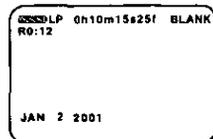

## Remote Control (Optional, page 59)

You can operate the major functions of your Palmcorder from up to approximately 16 feet (5 m) away (indoors). Aim the IR Remote Control toward the front of the Palmcorder and press the desired buttons (Remote Sensor is located under the lens).

### To operate Camera functions:

Set **POWER** to **CAMERA**.

### To operate VCR functions:

Set **POWER** to **VCR**.

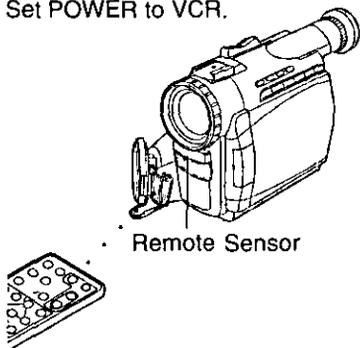

### Controlled Functions

- Rec/Pause (See page 22.)
- Tele (Zoom) (See page 22.)
- Wide (Zoom) (See page 22.)
- Date/Time (See page 20.)
- Reset (See page 51.)
- PhotoShot (See page 41.)
- Display On TV (See page 31.)
- Counter/Time Code (See page 19.)
- Audio Dubbing (See page 50.)
- Record (See page 53.)
- Menu (See page 14.)
- Play (See page 27.)
- FF/Search (See page 28.)
- REW/Search (See page 28.)
- Pause/Select (See pages 14, 28.)
- Stop/Set (See pages 14, 27.)
- Slow/Frame Advance (Forward) (See pages 28, 29.)
- Slow/Frame Advance (Backward) (See pages 28, 29.)
- Index Search (Forward) (See page 30.)
- Index Search (Backward) (See page 30.)
- Speaker Volume (See page 27.)

# Remote Control (Optional)

## Remote Controlling Two Palmcoders

You can control any two Panasonic Palmcoders with one Remote control (Optional, page 59). In order for the remote to distinguish between the two units, it is necessary to set one of the Palmcoders to VCR 2. On the remote, press VCR 1 or VCR 2 to control the desired Palmcorder.

### Optional

**For VCR 2 :**  
Press these buttons at the same time.

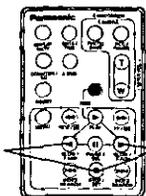

**For VCR 1 :**  
Press these buttons at the same time.

### Note

- When the Palmcorder and remote are not set to the same mode (VCR1 or VCR2), "CHECK REMOTE MODE (REMOTE)" will appear.



- 1 Set the POWER to VCR or CAMERA.**
  - The POWER Lamp lights red.
  - Be sure POWER is fully turned to VCR or CAMERA position.
- 2 Press MENU** to display the VCR or CAMERA mode menu screen.
- 3 Rotate JOG KEY** to select **CAMERA SET-UP** in the CAMERA mode menu screen or **VCR PLAY MODE** in the VCR mode menu screen, then **press JOG KEY** to display the CAMERA SET-UP or VCR PLAY MODE menu screen.
- 4 Rotate JOG KEY** to select **REMOTE**, and then press JOG KEY to select VCR 2. (See pages 16, 17). Leave the other Palmcorder set to VCR1.
- 5 Set the Remote Control (Optional, page 59) to VCR 1 or VCR 2** to correspond with the Palmcorder you wish to control. (See above left.)

- After replacing the Remote Control Battery, the remote will default to VCR 1.

## Replace the Battery

### Optional

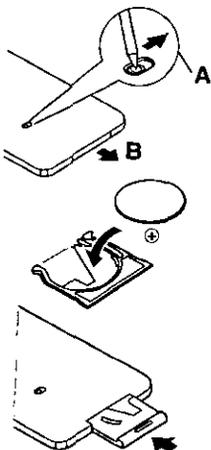

- 1** Insert a slender pointed object, such as the tip of a ball-point pen into the slot so that it fits into the hole (as shown **A**). Then, while sliding to the right, pull the Battery Tray out with your fingernail.
- 2** **Insert the battery** into the Battery Tray with the  $\oplus$  mark facing down.  
Do not reverse the polarity.
- 3** **Insert the Battery Tray.**

Replace battery with Panasonic PART NO. VSBW0004 (CR2025) only. Use of another battery may present a risk of fire or explosion. Caution: battery may explode if mistreated. Dispose of used battery properly. Keep away from children. Do not recharge, disassemble or dispose of in a fire.

# Playback Your Recordings

## Playback using the LCD Monitor

You can also use the LCD monitor to playback your recording.

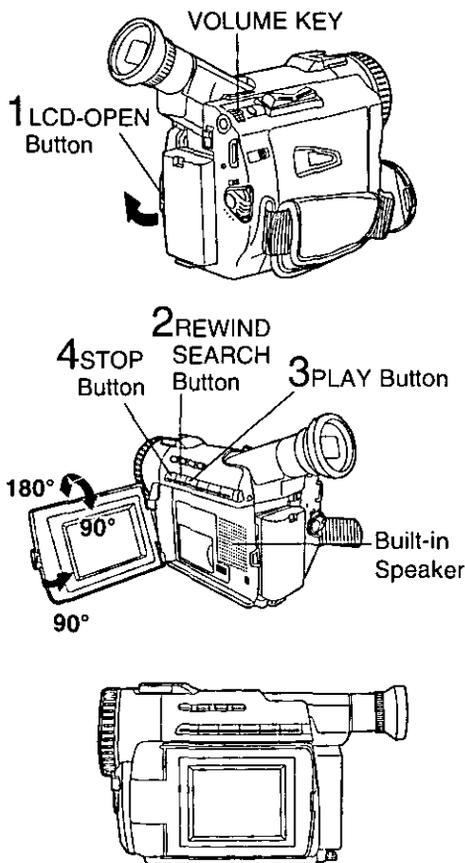

You can place the Palmcorder on a table, etc. for viewing. Rotate the LCD Monitor 180° and swing it up against the Palmcorder body as shown.

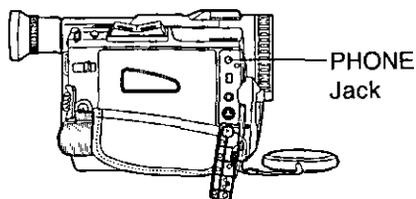

## Before you begin

- Connect the Palmcorder to a power source. (See pages 11, 12.)
- Insert a recorded cassette.
- Set POWER to VCR.

**1** Press **LCD-OPEN** to unlock the LCD monitor and swing open.

**2** Press **REWIND/SEARCH** to rewind the tape.

**3** Press **PLAY** to start playback.

## To adjust the volume:

**A** Hold down **VOLUME KEY** until the volume setting screen appears. (See page 20).

**B** Rotate **VOLUME KEY** to adjust the volume of the built-in speaker. To remove the volume setting screen, hold down **VOLUME KEY** again.

• Adjust the picture on the LCD monitor if needed. (See page 23.)

**4** Press **STOP** to stop playback.

- When the tape reaches its beginning during rewind or rewind search, it will stop automatically.
- If you press **PLAY** for more than 5 seconds, the Palmcorder will go into Repeat Playback mode when the tape reaches its end. The letter "R ▷" will appear in the EVF and LCD monitor. To exit the Repeat Playback mode, turn the Palmcorder OFF.

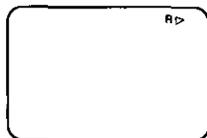

## Note

- When a tape recorded in LP mode on another digital video camera is played back on this unit, the picture may appear mosaic.
- Using the LCD monitor reduces battery operating time.
- You can connect earphones (not supplied) to the PHONE Jack.

# Playback Your Recordings

## Special Effect Features During Playback

### Note

- Sound is muted during all special effects.

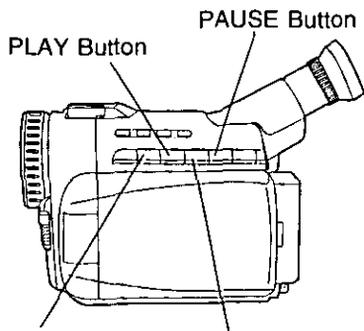

A, B REWIND/  
SEARCH Button

A, B FAST FORWARD/  
SEARCH Button

### Optional

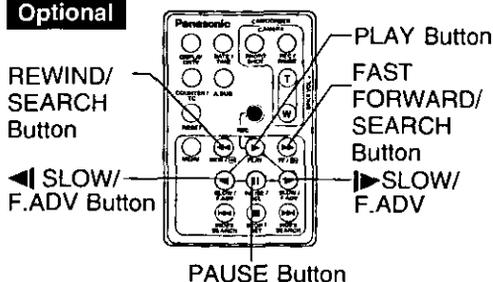

## Fast Forward/Rewind Check

Monitor normal picture playback during fast forward or rewind.

- Hold down **FAST FORWARD/SEARCH** during fast forward.
- Hold down **REWIND/SEARCH** during rewind.
- The picture will appear for as long as the button is held down.

## Rapid Visual Search

**A** During playback, hold down **FAST FORWARD/SEARCH** or **REWIND/SEARCH**.

The search will continue for as long as the button is held down.

OR

**B** Press **FAST FORWARD/SEARCH** or **REWIND/SEARCH** once for a continuous rapid visual search. Press **PLAY** to release.

### Note

- When executing a rapid visual search, the picture may become bluish for an instant or mosaic. This is normal during this mode.



## STILL Picture

Press **PAUSE** during playback. Press **PLAY** or **PAUSE** to release.

### Note

- To protect the tape and video heads, your Palmcorder's operating modes will revert as follows:  
STILL → STOP (after 3 minutes.)

## Slow Motion Playback

**Optional Remote Control Only**  
(See page 59)

Forward Slow = Press **▶ SLOW/F.ADV** during play.

Reverse Slow = Press **◀ SLOW/F.ADV** during play.

Press **PLAY** to release. (During reverse slow motion playback, time code indication may not change regularly.)

### Note

- Palmcorder will automatically STOP when in slow motion for more than 10 minutes.
- During slow motion playback, picture may move up and down. This is normal.
- When you start or stop slow motion playback, the picture may become bluish for an instant.

# Playback Your Recordings

## Special Effect Features During Playback (Continued)

### Note

- Sound is muted during all special effects.

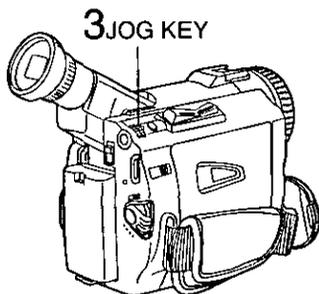
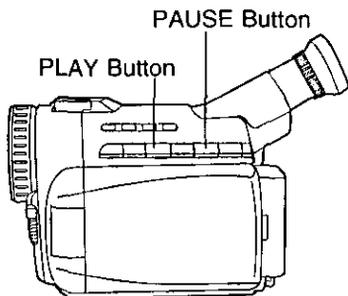

### Optional

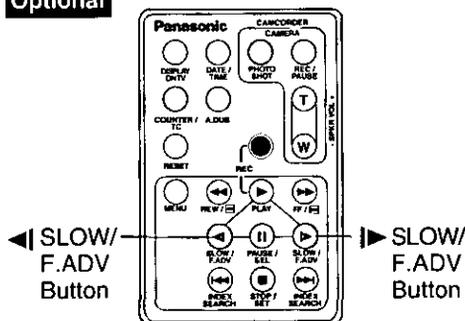

## Variable Speed Search

- 1 Press PLAY to start playback.
- 2 Press PLAY again.
- 3 Rotate JOG KEY to adjust the playback speed.
  - Rotate JOG KEY downward for forward playback.
  - Rotate JOG KEY upward for reverse playback.

**To return to normal playback:**  
Press PLAY. Playback will continue at normal speed.

### Note

- The Variable Speed Search function offers a choice of six playback speeds (1/5X, 1X, 2X, 5X, 10X, 20X) both in forward and reverse directions.
- The review playback at the 1X speed is playback in reverse direction.
- During the Variable Speed Search (at a speed other than 1X), mosaic-like patterns will appear in the picture.
- During the Variable Speed Search, sound is muted.

## Jog Frame by Frame Search

(Palmcorder only)

During Still mode, rotate JOG KEY to advance or reverse the picture one frame at a time.

## Frame by Frame Advance

Optional Remote Control Only  
(See page 59)

Press PAUSE during playback.

Press ► SLOW/F.ADV to do a frame by frame advance.

Press ◀ SLOW/F.ADV to do a frame by frame reverse.

Press PLAY to release.

### Note

- If you hold down SLOW/F.ADV, you can see a continuous series of still images at a slower speed than normal slow mode.
- During frame by frame advance, a few frames may move automatically, and the picture may become bluish for an instant.

# Playback Your Recordings

## Special Effect Features During Playback (Continued)

### Note

- Sound is muted during all special effects.

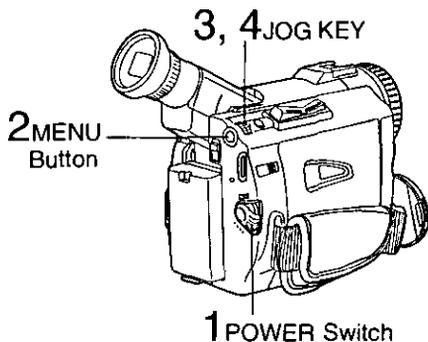

### Optional

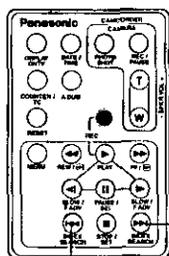

**B** INDEX SEARCH (rewind) Button

### Top Scan

If you hold down INDEX SEARCH more than 2 seconds, the Palmcorder will scan for scenes (or PhotoShots) and playback the first few seconds of each.

To cancel this function, press PLAY or STOP.

### Note

- Search will not work if there is a succession of PhotoShots.

## Index Forward/Reverse Search

Optional Remote Control Only (See page 59)

Search for a particular scene by using the electronic index marks placed at the beginning of each recording.

- 1** Set the **POWER** to **VCR**.
  - The **POWER** lamp lights red.
  - Be sure **POWER** is fully turned to **VCR** position.
- 2** Press **MENU** to display the **VCR** mode menu screen.
- 3** Rotate **JOG KEY** to select **PLAY MODE**, then press **JOG KEY** to display the **VCR PLAY MODE** menu screen.
- 4** Rotate **JOG KEY** to select **INDEX**, and then press **JOG KEY** to select **PHOTO** or **SCENE**. (See page 17.)

- A** Place the Palmcorder in the **VCR STOP** mode.
- B** Press **INDEX SEARCH** fast forward or rewind for the number of recordings (indexes) forward or back you want to view. The Palmcorder will advance or rewind to the desired recording and automatically start playback.
  - The number of times you pressed the button is displayed in the **EVF** and the **LCD** monitor if you set **INDEX** on the **VCR** menu to **SCENE**. (See page 17.) (Ex., if you press the button three times, "S3" will appear.)
  - If the interval between scenes is less than 1 minute, index search may not operate properly.
  - Response time from pressing the button and the change in the scene number is quite slow. Do not press **INDEX SEARCH** rapidly and continuously.
  - During **Reverse Index Search** mode, playback will not begin when a tape rewinds all the way to the beginning.

# Playback Your Recordings

## View Recording/Playback on your TV

[ TV with AUDIO/VIDEO IN Jacks ]

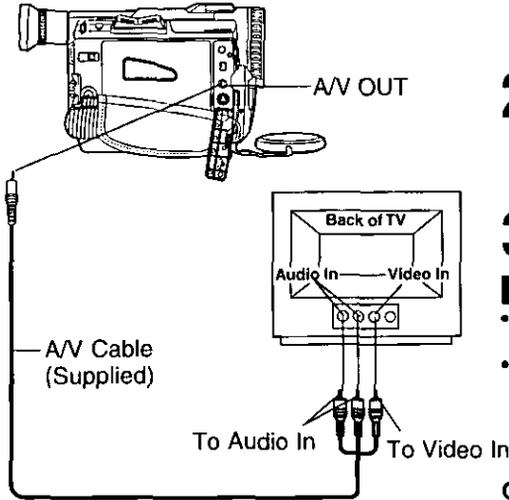

[ TV with S-VIDEO IN Jacks ]

For best Chrominance and Luminance, use the S-Video connection if available on your TV.

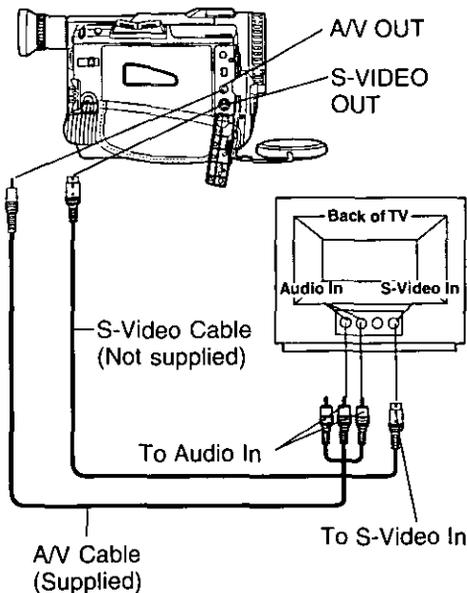

**1** Set **POWER** to **CAMERA** or **VCR**.  
To view what the Palmcorder is recording or to playback a tape on your TV.

**2** Turn your TV **ON** and set it to **LINE INPUT** or **S-VIDEO**.  
Check your TV operating instructions for further information.

**3** Start playback or begin a recording.

### Note

- Make sure the Palmcorder and TV are turned off while connecting.
- Please connect the A/V Cable securely.

### Optional Remote Control Only (See page 59)

You can display the various EVF and LCD indications on your TV by pressing **DISPLAY ON TV** on remote control. Press again to remove the indications.

DISPLAY  
ON TV  
Button

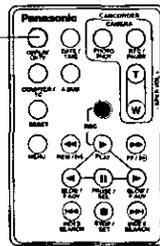

### CATV System Installer

This reminder is provided to call the CATV system installer's attention to Article 820-40 of the NEC in USA (and to the Canadian Electrical code in Canada) that provides guidelines for proper grounding and, in particular, specifies that the cable ground shall be connected to the grounding system of the building, as close to the point of cable entry as practical.

# Card Features

## Card PhotoShot

You can record still images to a Memory Card.

### Warning

- Memory Card will not work when DV interface Cable (i.LINK) is connected.

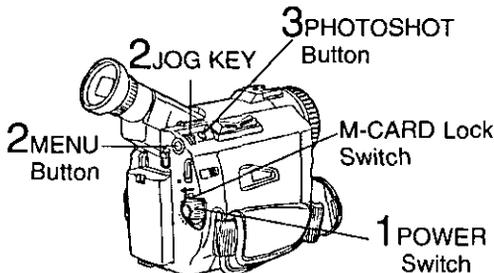

## Image Resolution and Capacity (supplied 8 MB MultiMediaCard)

REC Mode	Image Resolution	Capacity
FINE	640 x 480	Approx. 60 images
NORMAL	320 x 240	Approx. 240 images

- The number of images given for each mode applies when all images are taken in same mode.
- You can change recording modes at any time before capturing an image.
- The number of images that can be captured may differ depending on the subject. After capturing an image, the number may not decrease, or it may decrease by two. This is normal.

### Warning

- While "PROCESSING" is displayed, **DO NOT turn off the Palmcorder or unplug the AC Adaptor** (supplied) because this will cause irreversible damage to the memory.

## Before you begin

- Connect the Palmcorder to a power source. (See pages 11, 12.)
- Set POWER to OFF before inserting a Memory Card. (See page 10.)

- 1 Slide the M-CARD Lock Switch to unlock, then set POWER to M-CARD.**
  - The POWER lamp lights red.
  - Be sure POWER is fully turned to M-CARD position.
  - "PLAY: PUSH PLAY KEY" is displayed for 10 seconds. (See page 33.)
- 2 Press MENU to display CARD SETTING menu, then press JOG KEY to select **NORMAL** or **FINE**.**

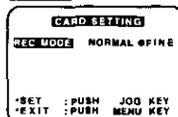

- 3 Press MENU to exit this menu.**
- 3 Press PHOTOSHOT to record an image.**

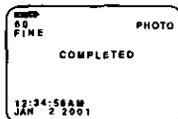

- The PhotoShot image is recorded to the Memory Card.
- When SHUTTER is set to ON (see page 15), still pictures are recorded with a visual shutter effect and click sound. If set to OFF, the still image will be displayed only.

## Cautions for the Memory Card

- While Memory Card data is being read, do not remove it, turn off the power, or subject unit to vibrations and shocks.
- Do not leave the Memory Card in a place with high temperature, exposed to direct sunlight, or where electromagnetic waves and static electricity can be generated.
- Electromagnetic waves, static electricity, malfunction of the Palmcorder or of the Memory Card itself could erase the data recorded on it. To prevent the loss of picture data, we recommend that you make a backup copy on the computer.
- Do not bend or drop the Memory Card as this could damage it or the captured contents.
- Do not touch the connector on the rear edge of the Memory Card with your fingers and take care that no dirt, dust or water enters it.
- Do not affix other labels to the Memory Card face or back as Card insertion/removal may become impossible.

## Recording images From a Tape

You can record still images from a cassette tape to a Memory Card.

### Warning

- Memory Card will not work when DV interface Cable (i.LINK) is connected.

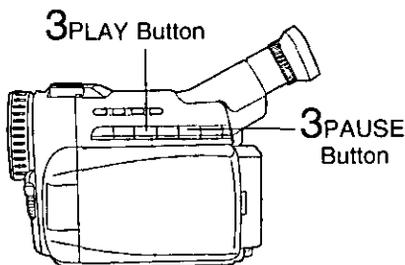
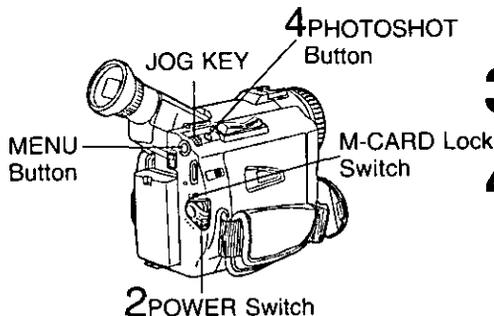

## Playback Still Images

You can view the images on the Memory Card.

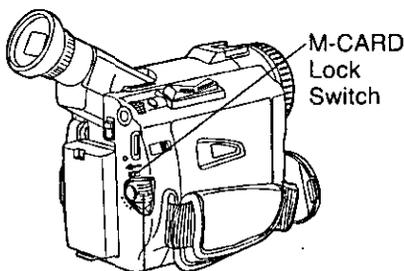

1 POWER Switch

## Before you begin

- Connect the Palmcorder to a power source. (See pages 11, 12.)
- Set POWER to OFF before inserting a Memory Card. (See page 10.)

- 1 Repeat steps 1 and 2 on page 32.
- 2 Set POWER to VCR.
  - The POWER lamp lights red.
  - Be sure POWER is fully turned to VCR position.
- 3 Press PLAY to start playback of the cassette tape. And then, press PAUSE to select an image.
- 4 Press PHOTOSHOT to record the desired image to the Memory Card.



- When PHOTOSHOT is pressed in PLAY or SLOW mode, the screen goes to STOP mode.
- To playback the images of the Memory Card, see pages 33-34.
- When Variable Speed Search is done (see page 29), this feature can not be used.

- 5 Repeat steps 3-4 to record another image to the Memory Card.

## Before you begin

- Connect the Palmcorder to a power source. (See pages 11, 12.)
- Set POWER to OFF before inserting a recorded Memory Card. (See pages 32, 33.)

- 1 Slide the M-CARD Lock Switch to unlock, then set POWER to M-CARD.
  - The POWER lamp lights red.
  - Be sure POWER is fully turned to M-CARD position.
  - "PLAY: PUSH PLAY KEY" is displayed for 10 seconds.

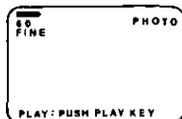

(Continued on next page.)

# Card Features

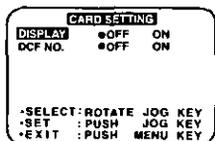
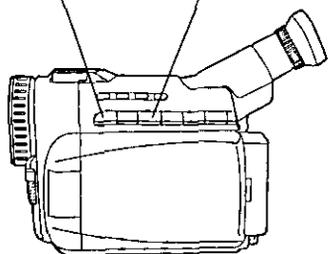
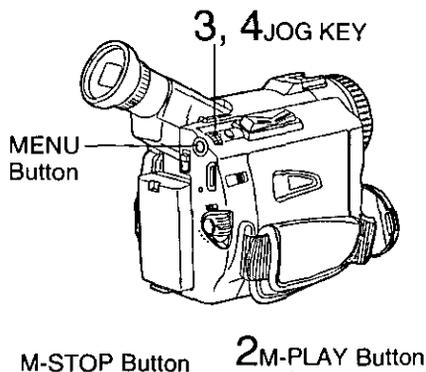

**DISPLAY** : Select OFF to remove all displays from the screen.

**DCF (Design rule for Camera File system)**

: Select OFF to cancel DCF No. on the screen.

## Note

- If the file number is changed, the Palmcorder cannot read the file data.
- This product is compliant with DCF (Design rule for Camera File System). Images saved on the Memory Card using other Digital Still Cameras that are compliant with DCF can be viewed on this product.

- 2 Press M-PLAY** to display the Multi playback screen.

  - "PLEASE WAIT" appears on-screen.
  - Rotate JOG KEY to scroll through Multi image screen pages (6 images per page) and select an image.
  - The selected image is underlined in green.

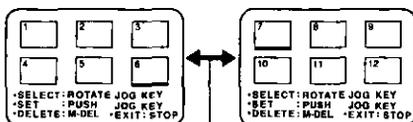

"PLEASE WAIT" is displayed.

- Press MENU to display CARD SETTING menu screen.
- Press M-STOP to return to the Card PhotoShot REC Mode. (See page 32.)

- 3 Press JOG KEY** to display the selected image as a full-size screen.

  - "PLEASE WAIT" appears on-screen.

- 4 Rotate JOG KEY** to select **BACK** (previous image), **MULTI** (Multi Image screen), or **NEXT** (next image).

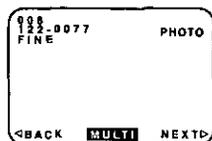

- Press M-STOP to return to the Multi Playback screen.

## Warning

- While "PLEASE WAIT" is displayed, **DO NOT** turn off the Palmcorder or unplug the AC Adaptor (supplied) because this will cause irreversible damage to the memory.

## Delete Specific Images

You can delete unwanted images and increase the remaining image memory.

### Warning:

Once deleted, images cannot be restored.

### DELETE PAGE

Delete specific images from a page.

### DELETE ALL

Delete all images. (See page 36.)

### FORMAT

Delete all data. (See page 37.)

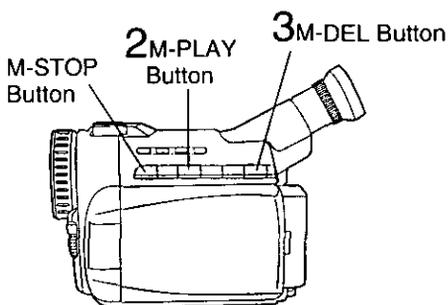
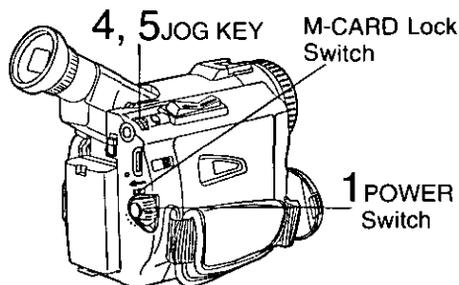

### Warning

- While deleting image, **DO NOT** turn off the Palmcorder or unplug the AC Adaptor (supplied) because this will cause irreversible damage to the memory, resulting in reduced image storage capacity.

## Before you begin

- Connect the Palmcorder to a power source. (See pages 11, 12.)
- Set POWER to OFF before inserting a recorded Memory Card. (See pages 32, 33.)

- 1 Slide the M-CARD Lock Switch to **unlock**, then set POWER to M-CARD.
  - The POWER lamp lights red.
  - Be sure POWER is fully turned to M-CARD position.
  - "PLAY: PUSH PLAY KEY" is displayed for 10 seconds.

- 2 Press M-PLAY to display the Multi playback screen.
  - "PLEASE WAIT" appears on-screen.

- 3 Press M-DEL to display the DELETE menu, then **rotate and press JOG KEY** to select **DELETE PAGE**.

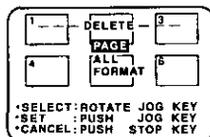

- DELETE PAGE menu is displayed.

- 4 Rotate and press JOG KEY to select and set the image to be deleted.
  - The selected image is underlined in pink.

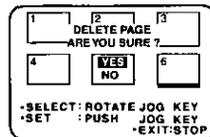

- 5 Rotate JOG KEY to select **YES**, and press JOG KEY to delete the selected image.
  - To cancel delete, press M-STOP or rotate and press JOG KEY to select NO.
  - "PLEASE WAIT" appears on-screen.
  - To delete other images, repeat steps 4-5.

# Card Features

## Delete All Image Pages

You can delete all images from the Memory Card easily with this operation.

### Warning:

Once deleted, images cannot be restored.

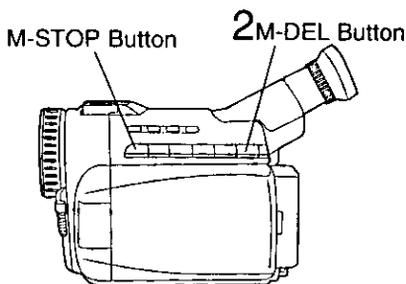
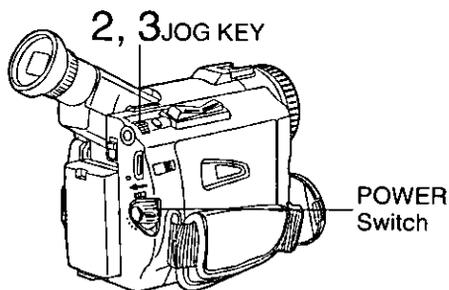

## Before you begin

- Connect the Palmcorder to a power source. (See pages 11, 12.)
- Set POWER to OFF before inserting a recorded Memory Card. (See pages 32, 33.)

**1** Do steps 1 and 2 on page 35.

**2** Press M-DEL to display the DELETE menu. Then, rotate and press JOG KEY to select **ALL**.

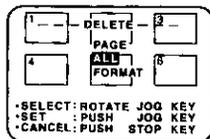

- The screen below is displayed.
- To cancel delete, press M-STOP or rotate and press JOG KEY to select NO.

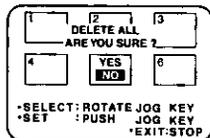

**3** Rotate and press JOG KEY to select **YES**.

- "PLEASE WAIT" is displayed on the screen, and then "NO PICTURE" is displayed.

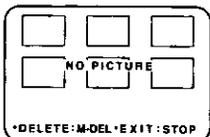

- Press M-STOP to return to the Card PhotoShot REC Mode screen. (See page 32.)

## Warning

- While deleting image, **DO NOT** turn off the Palmcorder or unplug the AC Adaptor (supplied) because this will cause irreversible damage to the memory, resulting in reduced image storage capacity.

## Format the Memory Card

You can easily format your Memory Card using this operation.

### Warning:

Formatting permanently removes all image data.

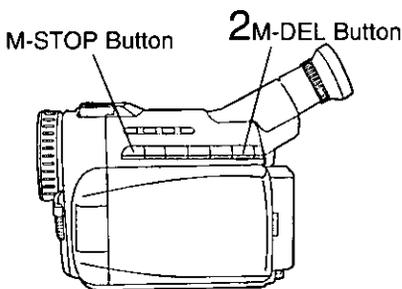
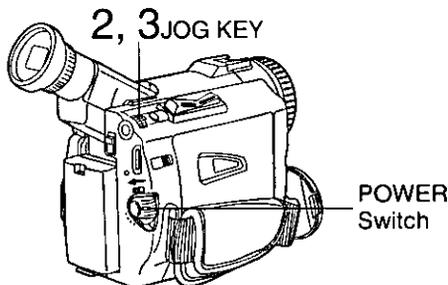

### Warning

- While deleting image, **DO NOT** turn off the Palmcorder or unplug the AC Adaptor (supplied) because this will cause irreversible damage to the memory, resulting in reduced image storage capacity.

## Before you begin

- Connect the Palmcorder to a power source. (See pages 11, 12.)
- Set POWER to OFF before inserting a recorded Memory Card. (See pages 32, 33.)

**1** Do steps 1 and 2 on page 35.

**2** Press M-DEL to display the DELETE menu, then rotate and press JOG KEY to select **FORMAT**.

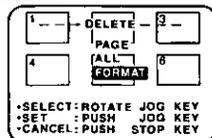

- The screen below is displayed.
- To cancel format, press M-STOP or rotate and press JOG KEY to select NO.

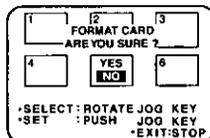

**3** Rotate and press JOG KEY to select **YES**.

- "PLEASE WAIT" is displayed on the screen as all image data is deleted from Memory Card. Deletion is complete when "NO PICTURE" is displayed.

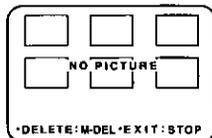

- Press M-STOP to return to the Card PhotoShot REC Mode screen. (See page 32).

# Card Features

## Photo Title

You can record PhotoShot images from a Memory Card to a cassette to be used as a WIPE or MIX effect.

### Note

When Photo Title is set to ON, the selected image and Title will appear before each recording is made.

**WIPE** : The Photo title is replaced with the current scene in a wiping motion.



**MIX** : The photo title is replaced with the current scene in a gradual mixing effect.

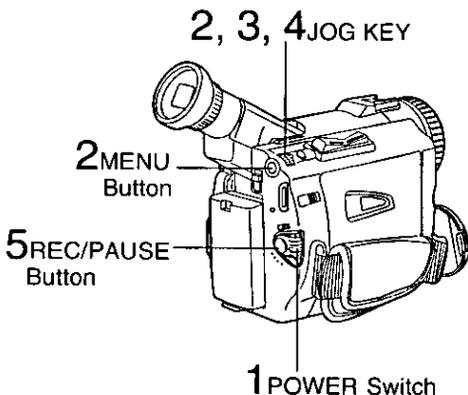

## Before you begin

- Connect the Palmcorder to a power source. (See pages 11, 12.)
- Set POWER to OFF before inserting a recorded Memory Card. (See pages 32, 33.)

### 1

Set POWER to CAMERA.

- The POWER lamp lights red.
- Be sure POWER is fully turned to CAMERA position.

### 2

Press MENU to display the CAMERA menu screen. Then rotate and press JOG KEY to select **PHOTO TITLE**.



### 3

Rotate and press JOG KEY to select and set **MODE** and then **TITLE**.

1st : Select and set MODE (WIPE or MIX).

2nd : Select and set TITLE to "SET".

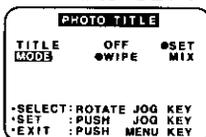

- "PLEASE WAIT" appears on-screen.
- The Multi image screen is displayed.

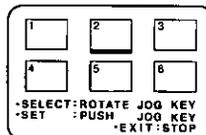

### 4

Rotate and press JOG KEY to select and set an image.

- "PLEASE WAIT" is displayed while image is processed. Then, "PHOTO TITLE SET" is displayed for approx. 3 seconds, and the screen goes back to the Camera mode screen.
- After Photo Title is performed, Digital Function turns off.
- There are 12 pre-installed files.

### 5

Press REC/PAUSE to start recording with Photo Title.

- WIPE or MIX screen is displayed at beginning of the recording. Then the Photo Title setting will be cleared automatically.

## Dual Digital Electronic Image Stabilization System (D.E.I.S.)

This feature helps compensate for any unintentional hand or body movement. It can be used in both the Recording and Playback (VCR) modes.

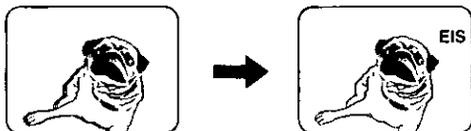

**NORMAL**

**EIS ON**

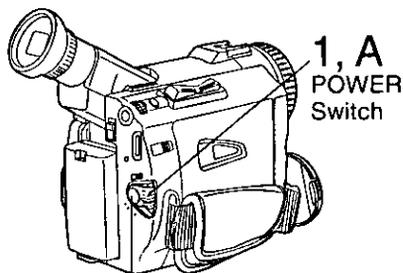

**1, A**  
POWER  
Switch

**3** REC/PAUSE Button

**2, 4, C, D**  
EIS Button

**B** PLAY Button

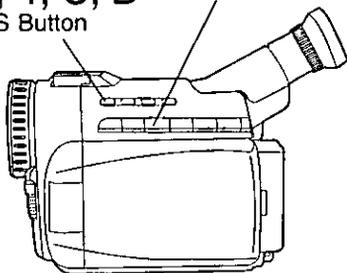

### Note

- Other Digital Functions are turned off automatically when the EIS and Digital Zoom are selected.

## CAMERA mode

- 1** Set **POWER** to **CAMERA**.
  - The **POWER** lamp lights red.
  - Be sure **POWER** is fully turned to **CAMERA** position.
- 2** Press **EIS** to stabilize the picture.
  - Picture flicker may be observed when taping under fluorescent lighting conditions.
  - The **EIS** indicator flashes when the light level is inadequate.
  - Turn **D.E.I.S.** OFF during recording when using a tripod.
- 3** Press **REC/PAUSE** to start recording.
- 4** Press **EIS** again to cancel.
  - Be sure that **D.E.I.S.** is turned off when not needed.

### D.E.I.S. may not function when...

- Palmcorder movement is too extreme.
- Recording a subject with distinct horizontal or vertical stripes.
- Recording in low light situations.
- Recording a subject under a great amount of fluorescent light.
- Recording a scene with very fast motions.

## VCR mode

- A** Set **POWER** to **VCR**.
  - The **POWER** lamp lights red.
  - Be sure **POWER** is fully turned to **VCR** position.
- B** Press **PLAY** to start playback.
- C** Press **EIS** to stabilize the picture.
- D** Press **EIS** again to cancel.
  - Be sure that **D.E.I.S.** is turned off when not needed.

### Note

- When using **D.E.I.S.** in **VCR** mode, the image size is slightly larger.

# Special Features

## Digital Zoom

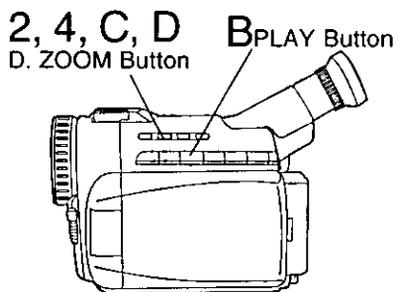
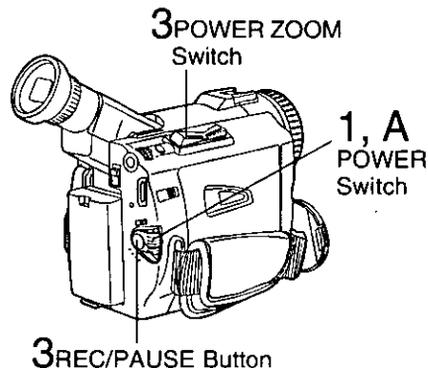

Zoom In ("T")



Zoom Out ("W")

### Note

- Other Digital Functions are turned off automatically when the EIS and Digital Zoom are selected.

## CAMERA mode

- 1 Set POWER to CAMERA.**
  - The POWER lamp lights red.
  - Be sure POWER is fully turned to CAMERA position.
- 2 Press D. ZOOM to select D.ZOOM1 or D.ZOOM2.**
  - once** : D.ZOOM1 (from 18X to 36X)
  - twice** : D.ZOOM2 (from 18X to 300X)
  - three times** : Turn off D.ZOOM
- 3 Press REC/PAUSE to start recording and press POWER ZOOM to zoom in or zoom out.**
  - The magnification level is always displayed in the EVF or the LCD monitor when DISPLAY is set to ON. (See pages 16, 18.)
- 4 Press D.ZOOM to turn off Digital Zoom so that no indication appears.**

### Note

- The normal optical zoom functions from 1X to 18X.
- Because the image is enlarged digitally, the picture may become distorted when higher magnification levels are used.
- When the level falls below 18X, the normal zooming function will resume.
- Focus distance becomes 4 feet (1.2 m) if the lens is in full telephoto.

## VCR mode

- A Set POWER to VCR.**
  - The POWER lamp lights red.
  - Be sure POWER is fully turned to VCR position.
- B Press PLAY to start playback.**
- C Press D.ZOOM.**
  - The center portion of the image doubles in size.
- D Press D.ZOOM again for normal image size.**

## Digital PhotoShot

Use this feature to record a seven second (approx.) still image from the current camera picture. Audio is also recorded for on-the-spot narration. Or, you can add narration later with the Audio Dubbing feature to make an interesting slide show, etc. (See page 50.)

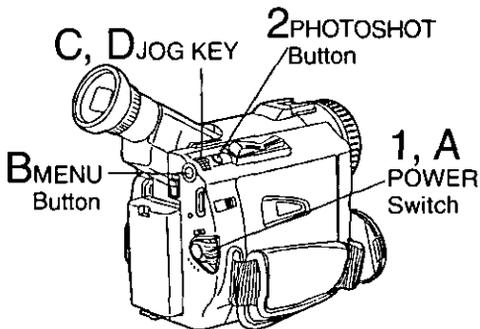

### 1

**Set POWER to CAMERA.**

- The POWER lamp lights red.
- Be sure POWER is fully turned to CAMERA position.

### 2

**Press PHOTOSHOT** in Record/Pause mode. "PHOTO" will appear in the EVF or the LCD monitor.



- If SHUTTER on the menu screen is set to ON, a sound effect similar to the shutter of a film camera will be heard when PHOTOSHOT is pressed.
- When PHOTOSHOT is pressed, the playback image takes approx. 7 seconds to process. After that, the Camera mode screen will be displayed.

## Index Search (Photo/Scene)

Optional Remote Control Only  
(See page 59)

Optional

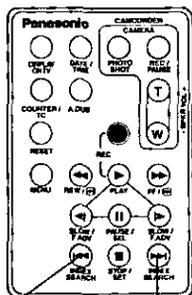

**E INDEX SEARCH**  
(rewind Button)

**E INDEX SEARCH**  
(fast forward Button)

### A

**Set POWER to VCR.**

- The POWER lamp lights red.
- Be sure POWER is fully turned to VCR position.

### B

**Press MENU** to display the VCR mode menu screen.

### C

**Rotate JOG KEY** to select **PLAY MODE**, and **press JOG KEY** to display the VCR PLAY MODE menu screen.

### D

**Rotate JOG KEY** to select **INDEX**, and **press JOG KEY** to select PHOTO or SCENE.

- Press MENU twice to exit.

### E

**Press INDEX SEARCH fast forward or rewind** on the remote control (Optional, page 59) to advance or rewind the tape to playback a PhotoShot scene. To view the next PhotoShot, INDEX SEARCH must be pressed again.

### Note

- The picture quality will deteriorate slightly.
- The tape remaining indicator will not appear while the PHOTOSHOT feature is used.
- In the Photo/Scene Index Search mode, the shutter sound effect may not be able to be heard even when SHUTTER is set to ON.
- Photo Index Search may fail to detect a recorded PhotoShot image if the image is 3 seconds or less.

# Special Features

## White Balance

Auto White Balance automatically maintains optimum color balance in most lighting conditions. However, when using Digital Functions, etc., you may get better results using the manual adjustment.

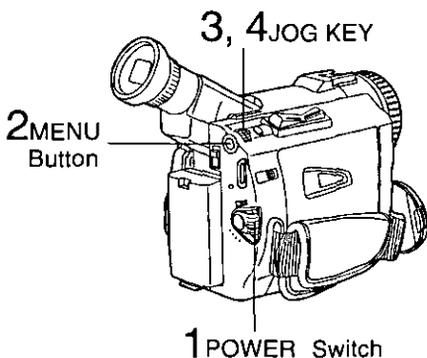

- 1 Set POWER to CAMERA.**
    - The POWER lamp lights red.
    - Be sure POWER is fully turned to CAMERA position.
  - 2 Press MENU** to display the menu screen.
  - 3 Rotate JOG KEY** to select **ADJUST**, and then **press JOG KEY** to display the CAMERA ADJUST menu screen.
  - 4 Rotate JOG KEY** to select **W: BALANCE**, and then **press JOG KEY repeatedly** to select AUTO, Indoor halogen lamp "☉", or Outdoors "☼".
    - ☉ : When the source illumination is a halogen lamp.
    - ☼ : When shooting outdoors on a sunny day.
- AUTO : Automatically maintains optimum color balance in most lighting conditions.

## Recording Still Pictures

You can record still pictures of any desired duration together with sound.

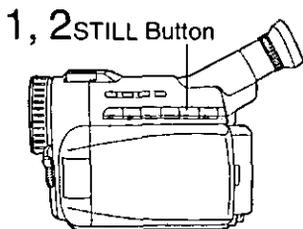

- 1 While in RECORD mode, press STILL and hold for 2 seconds** to capture a still picture. The captured still picture will be recorded together with sound.
- 2 Press STILL once again** to release the still picture. The camera will resume recording real-time pictures.

## Program AE

The Auto Exposure feature can be used to make quality recordings in a variety of scene situations.

### Note

- When MAGICVU is ON, Program AE and H.S.S. cannot be set in the menu.

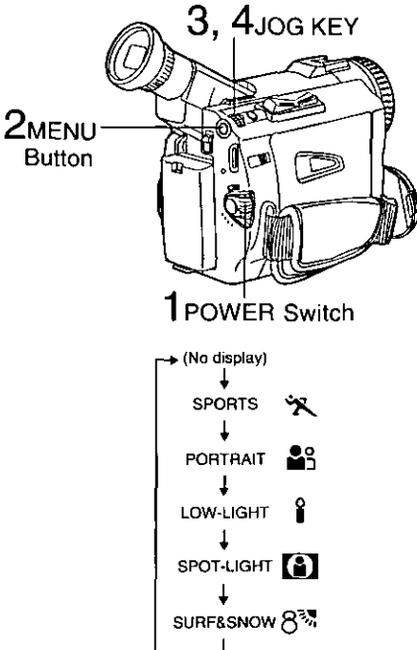

- 1 Set **POWER** to **CAMERA**.
  - The **POWER** lamp lights red.
  - Be sure **POWER** is fully turned to **CAMERA** position.
- 2 Press **MENU** to display the menu screen.
- 3 Rotate **JOG KEY** to select **ADJUST**, and then press **JOG KEY** to display the **CAMERA ADJUST** menu screen.
- 4 Rotate **JOG KEY** to select **PROG.AE**, then press **JOG KEY** repeatedly to select one of the five modes shown below.
- 5 Repeat steps 2-4 to select **OFF** to cancel this feature.

Mode	Indication
	For recording fast action scenes.
	For recording only subjects in the foreground, while ignoring subjects in the background.
	For recording in extreme low light conditions.
	Recording in situations where subjects are under a spotlight(s).
	For recording in locations with a high degree of "Dazzle," such as snow slopes and the seashore.

### Note

#### SPORTS mode

- The recorded images will not be so blurred when they are viewed later using slow or still picture playback.
- When playing back a sports mode recording, the movement may appear slightly jerky.
- Do not use this mode when recording under fluorescent, mercury, or sodium lighting. These types of lights will affect the color and brightness of the images.
- A vertical band of light might appear when recording objects that are brightly illuminated or which are highly reflective.
- If the amount of light is insufficient, the **SPORTS** "X" indicator will flash in the EVF or the LCD monitor.
- The image may flicker if this mode is used indoors.

#### PORTRAIT mode

- The image may flicker if this mode is used indoors.

#### LOW-LIGHT mode

- Scenes recorded in extremely low light levels may not come out properly.

#### SPOT-LIGHT mode

- If the recorded subject is extremely bright, the picture may appear whitish.

#### SURF&SNOW mode

- If the recorded subject is extremely bright, the picture may appear whitish.
- It is not possible to select the **SPORTS** mode or **PORTRAIT** mode together with the **GAIN UP** in the Digital function camera menu.

# Special Features

## Other Digital Functions

Use the following features to add interest and professionalism to your recordings or playback. Select from twelve special effects.

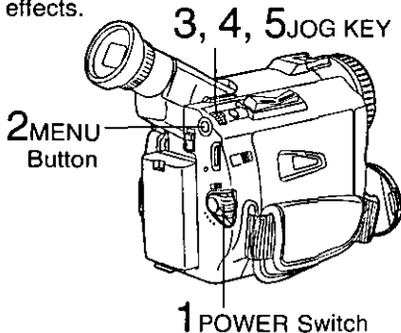

## Types of Digital Functions

### MIRROR

Symmetrical image from the current camera picture.

### STROBE

The recording appears as a sequence of still frames.

### MOSAIC

The picture appears in a mosaic pattern.

### SLIM

The picture is expanded vertically.

### TRAIL

The subject being recorded creates a trail when in motion.

### STRETCH

The picture is expanded horizontally.

### GAIN UP (Not available during playback)

Picture sensitivity is increased.

- Only Manual Focus is available.

### WIPE

Successive scenes are separated in a way which simulates the drawing of a curtain.

### MIX

The current scene is mixed in with the following scene during scene changes.

### PinP

PinP (Still image) is displayed on the Main Picture.

### SEPIA (Only available during playback)

The picture is played back in sepia, a brownish color, giving it an antique look.

### MONO (Monotone) (Only available during playback)

The picture is played back in black-and-white.

44

- 1 Set **POWER** to **CAMERA** or **VCR**.
  - The **POWER** lamp lights red.
  - Be sure **POWER** is fully turned to **CAMERA** or **VCR** position.

- 2 Press **MENU** to display the menu screen.

- 3 Rotate **JOG KEY** to select **D.FUNCTION** in the **CAMERA** mode menu screen or **PLAY FUNCTION** in the **VCR** mode menu screen, then press **JOG KEY** to display the **CAMERA FUNCTION** or **VCR PLAY FUNCTION** menu screen.

- 4 Rotate **JOG KEY** to select **D.FUNCTION**, and then press **JOG KEY** repeatedly to select one of the Digital Functions listed on the left.

- 5 To cancel the Digital Function, press **JOG KEY** repeatedly to select **OFF**.

### Note

- The **EIS** and **Digital Zoom** features are turned off automatically when one of the Digital Functions listed at left is selected.

### To use the WIPE function

- a. In Camera mode, set the "D.FUNCTION" item in the main menu screen to "WIPE". (See page 15.)
- b. Press **REC/PAUSE** to start recording.
- c. Press **REC/PAUSE** to pause the recording. The last scene will be memorized.
- d. Press **RECORD/PAUSE** to start recording again. The new scene will take the place of the memorized scene.

### To use the MIX function

- a. In Camera mode, set the "D.FUNCTION" item in the main menu screen to "MIX" (see page 15). Then, perform steps b-d above.

The memorized scene and the new scene will appear mixed as the scene changes from one to the other.

### Note

- When **Photo Title** is set, **WIPE/MIX** mode becomes **Photo Title**. When **Photo Title** is finished, Digital Function turns **OFF**.

## Picture in Picture (PinP)

You can display a PinP (still image) screen on the Main Picture.

### Note

- PinP position is fixed at the bottom right of the screen.

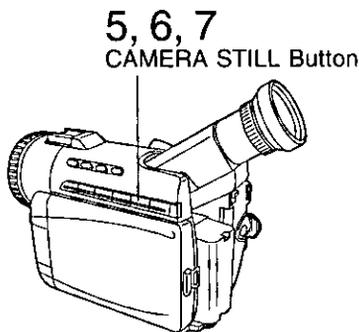
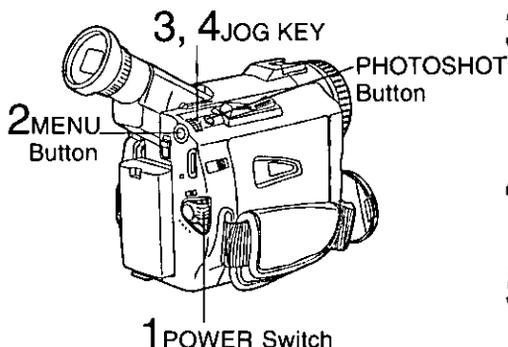
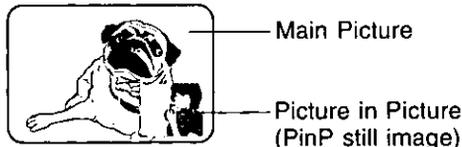

## Before you begin

- Connect the Palmcorder to a power source. (See pages 11, 12.)

- 1 Set POWER to CAMERA.**
  - The POWER lamp lights red.
  - Be sure POWER is fully turned to CAMERA position.
- 2 Press MENU** to display the menu screen.
- 3 Rotate JOG KEY repeatedly** to select **D.FUNCTION**, then **press JOG KEY** to display the CAMERA FUNCTION menu screen.
- 4 Press JOG KEY** to select **PinP**.
  - **Press MENU twice** to exit this menu.
- 5 Aim at the scene** you wish to place as PinP, then **press CAMERA STILL** to freeze the image.
- 6 Press CAMERA STILL again** to place the frozen image as PinP.
- 7 Press REC/PAUSE** to record a scene with PinP image.
  - **Press PHOTOSHOT** to record a scene with PinP image in PhotoShot mode.
  - **Press CAMERA STILL again** to remove PinP image.



# Special Features

## Strobe Multi Mode

In Strobe Multi Mode, you can select the rate at which a succession of still screens are captured from the playback picture.

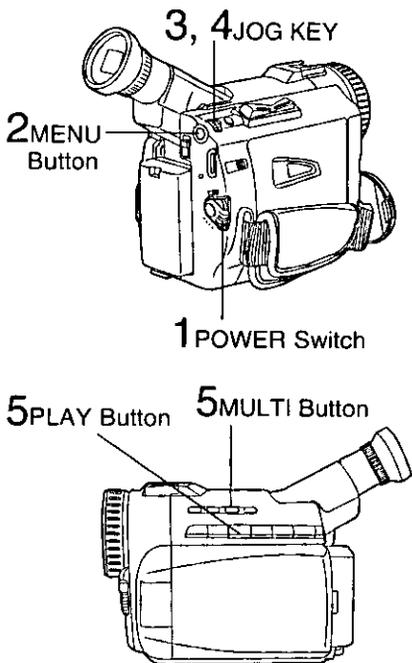

## Before you begin

- Connect the Palmcorder to a power source. (See pages 11, 12.)

- 1 Set POWER to VCR.**
  - The POWER lamp lights red.
  - Be sure POWER is fully turned to VCR position.
- 2 Press MENU** to display the menu screen.
- 3 Rotate and press JOG KEY** to select and set **MULTI-SETTING**.
- 4 Press JOG KEY** to select **SPEED**, then press repeatedly to set desired speed.

## Strobe Speeds

Strobe Speeds	9 screen capture time
FAST	Every 0.3 seconds
NORM	Every 0.6 seconds
SLOW	Every 1.0 seconds

- Press **MENU** twice to exit.
- 5 Press PLAY** to start playback. **Press MULTI** at the point you want to start capturing.
    - A succession of 9 screens will be captured, and playback will stop.

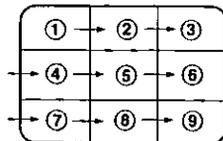

- Press **MULTI** to return to the normal STILL screen.
- Press **PLAY** to start playback.
- Press **STOP** to stop playback.

## Note

- A Multi Image Playback screen cannot be output from the DV terminal or Digital Still Image terminal.
- A Multi screen will have slightly lower image quality.

## Auto Focus

The Palmcorder automatically adjusts the focus over the entire zoom range.

## Manual Focus

Use Manual Focus (MF) when recording ...

- a subject through glass.
- a scene where the subject is far from the Palmcorder and there are objects in the foreground.
- a subject with distinct horizontal stripes.
- a subject not centered in the Viewfinder.
- subjects with shiny surfaces.
- an obliquely angled subject.
- a bright, flat subject such as a white wall.
- in low light situations.
- a scene with fast motions, like a golf swing.

**Re-focusing may be required**

- when your Palmcorder is aimed at a new scene.

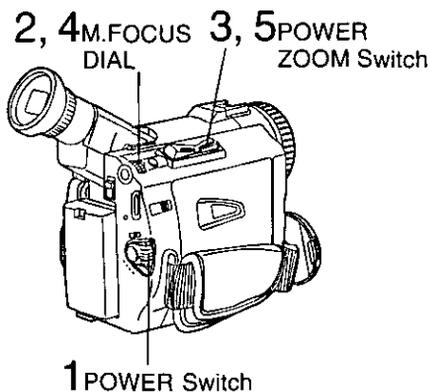

- 1 Set POWER to CAMERA.**
  - The POWER lamp lights red.
  - Be sure POWER is fully turned to CAMERA position.

- 2 Press M.FOCUS DIAL** so that "MF" (Manual Focus) appears in the EVF or the LCD monitor.

- 3 Press and hold POWER ZOOM "T" side (Telephoto)** until the lens is at maximum zoom in.

- 4 Turn M.FOCUS DIAL** until the picture is in focus.
  - It may be necessary to back away from the subject to focus the image properly.

- 5 Press POWER ZOOM to "W" or "T" as desired.**
  - The subject will remain in focus over the entire zooming range.
  - It may be necessary to back away from the subject to focus the image properly.

### Note

- DISPLAY must be set to ON for MF, AE, W.BALANCE, or BACK LIGHT to be displayed on the LCD or EVF.

## Macro Focus (for close-ups)

Press the "W" side of POWER ZOOM to the maximum wide angle position.

Auto Focus will function with the subject as close as 1 inch (25 mm) in front of the lens.

# Special Features

## Backlight

Use when recording a subject that is darker than the surrounding scene, in a shadowed area, or when the light source is in back of your subject.

BACK LIGHT Button

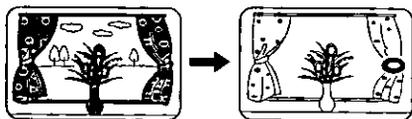
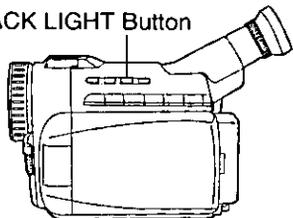

EVF or LCD monitor indication.

Press **BACK LIGHT** in **Record mode** to activate the Backlight feature.

The Indicator "●" will appear in the EVF or LCD monitor.

Press **BACK LIGHT** again to cancel the Backlight feature.

## Note

- The Indicator "●" will not appear in the EVF or LCD monitor when OFF is selected in the DISPLAY menu.

## Audio/Video Fade In/Out

You can make smoother scene transitions for a more professional look.

1, **A**FADE Button

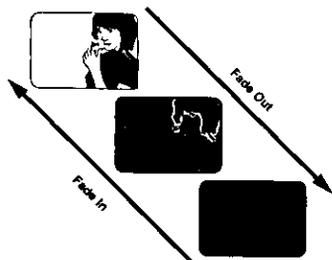
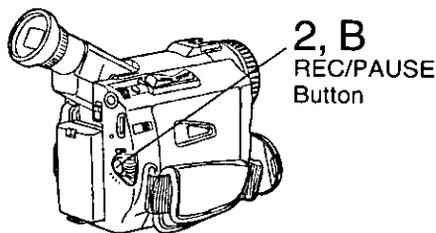
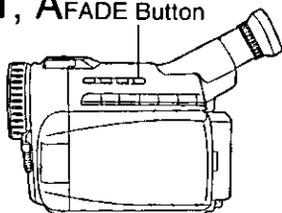

## Fade In

Starting the first scene with "fade in" is very effective.

**1** In **REC/PAUSE** mode, hold down **FADE** until the picture fades out.

**2** Press **REC/PAUSE** to start recording.

**3** Release **FADE** and the picture will gradually fade in.

## Fade Out

Use to create a soft ending or (together with fade in) for a soft transition from one scene to the next.

**A** During recording, hold down **FADE** until the picture fades out.

**B** Press **REC/PAUSE** to pause the recording.

## High Speed Shutter

To record high speed motion (e.g. tennis stroke) for improved STILL or SLOW MOTION playback when watching the tape on this Palmcorder.

## Auto Shutter

In the AUTO mode (no indication in the EVF and LCD monitor), the Palmcorder will automatically adjust the shutter speed (up to 1/350).

- AUTO mode is automatically selected whenever the POWER Switch is set to CAMERA.

## Manual Selection

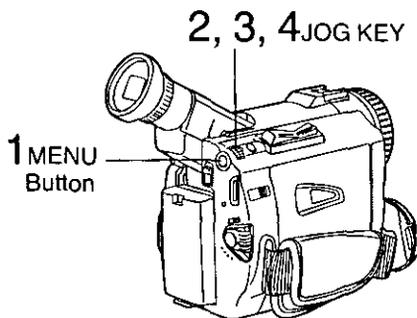

### Note

- For proper color reproduction, it is recommended that you use this feature outdoors. For indoor High Speed Shutter recording, additional halogen or tungsten light should be provided. Fluorescent light will degrade the picture quality.
- This feature requires ample light. More light is required for the fastest shutter speeds.
- The Auto Focus system may not operate properly in insufficient light when using the High Speed Shutter.
- When PROG.AE is ON, you cannot manually select the shutter speed.
- When MAGICVU is ON, Program AE and H.S.S. cannot be set in the menu.

## Before you begin

- Connect the Palmcorder to a power source. (See pages 11, 12.)
- Set POWER Switch to CAMERA.
- Insert a cassette with record tab. (See page 6.)

- 1** Press **MENU** to display the Camera mode menu in the EVF or the LCD monitor.
- 2** Rotate and press **JOG KEY** to select **ADJUST**, then rotate and press **JOG KEY** to select **H.S.S.**
- 3** Press **JOG KEY** to select **SET**.
  - SHUTTER SPEED menu is displayed.
- 4** Rotate **JOG KEY** to choose one of the following shutter speeds.

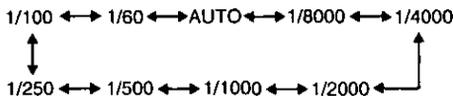
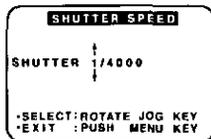

- Press MENU three times to exit.

# Special Features

## Audio Dubbing using the Built-in Microphone

The original sound can be replaced with new sound using the built-in Palmcorder microphone.

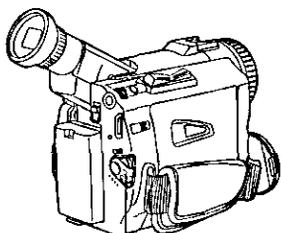
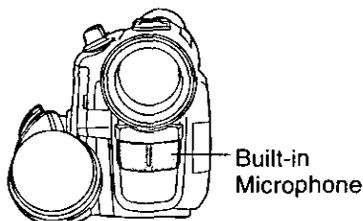

1 POWER Switch

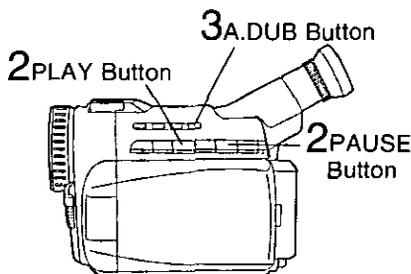

### Optional

3 A.DUB Button

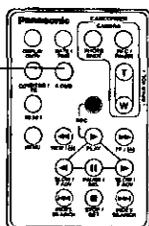

## Before you begin

- Turn on the Palmcorder.
- Insert a pre-recorded tape to be dubbed.

The AUDIO-REC setting in CAMERA MENU mode should be as follows:

12 bit	The original sound is recorded on ST (Stereo) 1, and the new sound will be recorded on ST (Stereo) 2.
16 bit	The original sound is replaced with the new sound.

- Select 12 bit if you do not want the original sound to be completely replaced during an audio dub.
- If you dub over a tape which has both 12 bit and 16 bit audio recordings on it, keep in mind that the original 16 bit audio portion will be completely replaced.

## 1

### Set POWER to VCR.

- The POWER lamp lights red.
- Be sure POWER is fully turned to VCR position.
- If you have the Optional Remote Control, you can set the Palmcorder to stop automatically at a specified point on the tape. See "Memory-Stop Editing" on page 51.

## 2

### Press PLAY.

Then press PAUSE where you want dubbing to begin.

## 3

Press A.DUB on this unit (for 3 seconds) or on the remote control (optional, page 59) to put the Palmcorder in the Audio Dub mode.

- "A.DUB" flashes in the EVF or the LCD monitor.

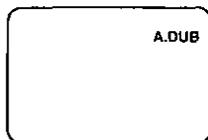

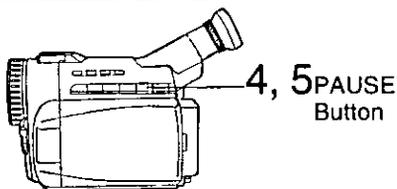

To listen to the desired audio sound, set the **AUDIO** setting of the VCR mode **MENU** (see page 17) as follows:

**AUDIO:**The following selections are available for 12 bit **AUDIO** dubbed recordings only (sound recorded in **SP** mode only).

<b>ST 1</b>	Set this position to listen to the original sound.
<b>ST 2</b>	Set this position to listen to the audio dubbed sound.
<b>MIX</b>	Set this position to listen to both the original sound and the audio dubbed sound.

### Note

- 16 bit dubbed sound completely erases the original 16 bit recorded sound.
- If you dubbed using 12 bit **AUDIO** recording and then selected **AUDIO-MIX** in the menu for playback, the sound will be stereo regardless of the **AUDIO-OUT** setting.
- If you recorded in **LP** mode, you cannot use the **A.DUB** feature.

- 4** Press **PAUSE** to start Audio Dubbing.
- Connect the Palmcorder to the TV in order to monitor the sound. (See page 31.)

INCOMPATIBLE  
TAPE

Only **NTSC** (National Television Standards Committee) recorded tapes can be audio dubbed. The following screen appears if the tape was not recorded in **NTSC** format.

- 5** Press **PAUSE** to stop Audio Dubbing.
- If the microphone used for dubbing gets too near the speaker of your TV, a howling noise (feedback) may occur.
  - If the tape position is in or was started in a blank section, you cannot use the **A.DUB** feature.

## Memory-Stop Editing (Optional Remote Control Only, page 59)

You can set an automatic Dubbing stop point.

### Optional

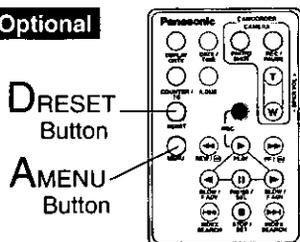

- A** Press **MENU** to display the VCR menu screen.
- B** Rotate **JOG KEY** to select **DISPLAY SETTING**, and then press **JOG KEY** to display the **DISPLAY SETTING** menu.
- C** Rotate **JOG KEY** to select **MEMORY**, and then press **JOG KEY** to set to **MEMORY**.
- D** Press **MENU** two times to exit **MENU** mode. Then, press **RESET** on the remote control to reset the Counter Memory to "M 0:00:00".

Now, rewind to the editing start point, and continue with steps 2-5. The tape will now stop automatically at "M 0:00:00".

# Special Features

## Copying your Tapes to S-VHS or VHS Cassette

Source (Playing)  
Palmcorder

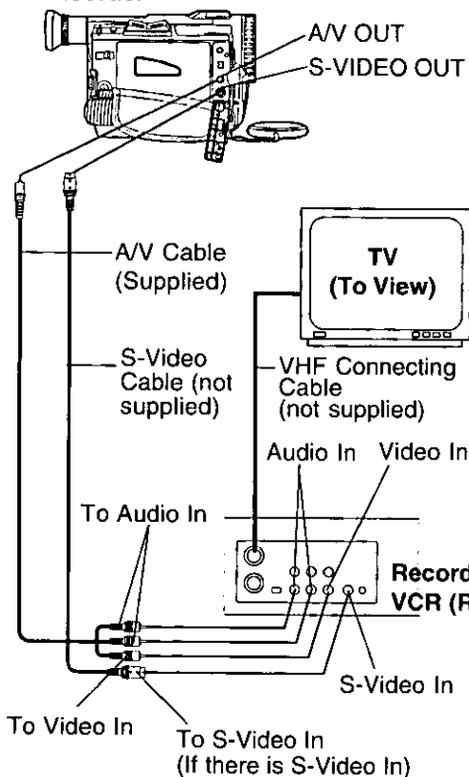

## Monitor with your TV

- Turn the TV ON and select its VCR channel (either CH3 or CH4).
- Set the VCR/TV Selector on the recording VCR to VCR.

## Before you begin

- Connect both Palmcorder and VCR to their power sources.
- Connect the Palmcorder to a VCR as illustrated left.
- Turn ON both units.
- **Set the recording VCR's Input Signal Selector to LINE.**
- Set the Palmcorder POWER Switch to VCR.

- 1** Insert a pre-recorded tape into the source (playing) Palmcorder and a blank tape, with record tab in place, into the target VCR (Recorder).
- 2** Press **PLAY** on the Palmcorder. When the tape reaches the point you want to start dubbing, **press PAUSE**.
- 3** Place the VCR into **REC/PAUSE mode**. (See VCR manual.)
- 4** Simultaneously, press **PAUSE** on both units to begin copying.
- 5** Press **STOP** on both units when copying is completed.

## Note

- For technical reasons, dubbing a tape may reduce its quality.
- Press **DISPLAY ON TV** on the Palmcorder remote control (optional, page 59) to eliminate EVF/LCD Monitor indications.
- If the Time Code is displayed in the EVF or LCD monitor, it cannot be reset.
- Only the **DATE/TIME**, when displayed, will be recorded on the tape.

## CAUTION:

Unauthorized exchanging and/or copying of copyrighted recordings may be copyright infringement.

## Copying from Digital Equipment (dubbing)

High quality digital-to-digital copying can be accomplished if both Palmcorders incorporate the DV Input/Output (i.LINK) Connector (DV interface cable (i.LINK) is not supplied).

### Source (Playing) Palmcorder

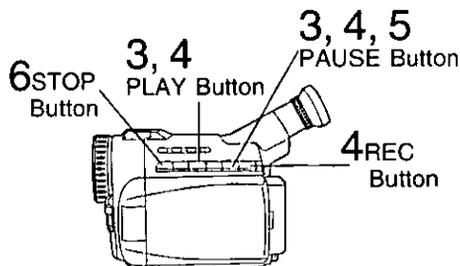
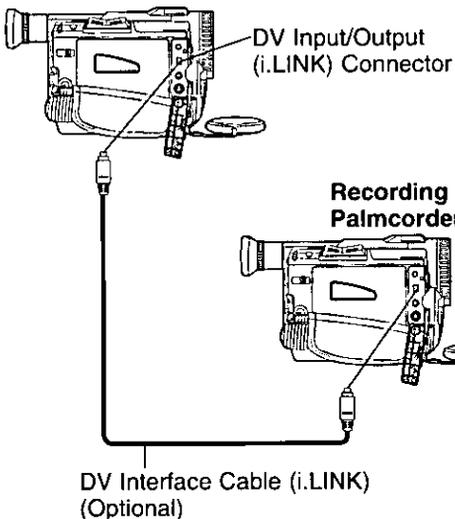

### Optional

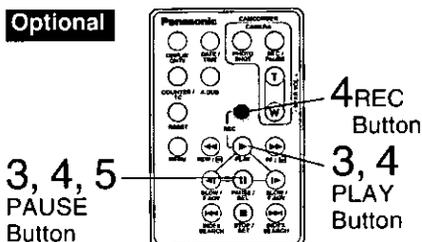

## Before you begin

- Connect both Palmcorders to their power sources.
- Connect the two Palmcorders using the DV interface cable (i.LINK) (4-pin to 4-pin).
- Turn both Palmcorders ON.

- 1 Insert a pre-recorded tape into the source (playing) Palmcorder, and set **POWER** to **VCR**.
- 2 Insert a blank tape with the record tab closed into the target (recording) Palmcorder and set **POWER** to **VCR**.
- 3 Press **PLAY** on the source Palmcorder. When the tape reaches the point you want to start dubbing, press **PAUSE**.
- 4 Hold down **REC** and press **PLAY** on the target (recording) Palmcorder or on the remote control (optional, page 59). Press **PAUSE** to pause the tape at the starting point of the dub.
- 5 Simultaneously, press **PAUSE** on both units to begin dubbing.
- 6 Press **STOP** on the recording unit, and then press **STOP** on the playing unit to end dubbing.

### Note

- When two Palmcorders are used for dubbing, it is recommended that the remote control VCR1 or VCR2 setting be used to avoid improper-operation.
- When two Palmcorders are connected using the DV interface cable (i.LINK) (not supplied), a Video Editing Controller cannot be used.
- Do not connect both an S-Video Cable or A/V Cable and a DV Interface Cable (i.LINK).

### CAUTION:

Unauthorized exchanging and/or copying of copyrighted recordings may be copyright infringement.

# Transferring Your Images

You can transfer images from your Palmcorder tape to your PC (Personal Computer).

## System Requirements:

- IBM PC/AT or compatible
- Intel Pentium II Processor: 266 MHz or more
- Windows 98/Me preinstalled PC with USB port
- RAM: 64 MB or more
- High color (16 bit) or more
- Resolution 800 x 600 (SVGA) or more
- 15 MB minimum available hard disk space (for CARDLINK (for USB)
- CD-ROM drive (for installation)
- Mouse or other pointing device

**Palmcorder USB Device Driver** : Software to connect your Palmcorder and your PC using USB Cable.

**CARD LINK (for USB)** : This software to transfer images between the Memory Card and your PC.

## Note

- The Windows 2000 driver is currently not available, but will be available in the future on our website at [www.panasonic.com/video](http://www.panasonic.com/video).

## Software Installation (Windows 98/Me)

### Caution

- Please install Palmcorder USB Device Driver first before connecting the Palmcorder and your PC using USB Cable. Once Palmcorder USB Device Driver is installed, you must restart your computer for installation to take effect.

**1** Turn on the PC (Personal Computer) and start up Windows 98/Me.

**2** Insert the supplied Software CD-ROM into the CD-ROM drive.

**3** Select and click the icon you want to install.

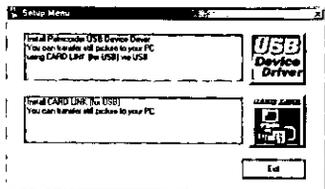

**Palmcorder USB Device Driver** : Click 

**CARD LINK (for USB)** : Click 

**4** Follow the instructions as they appear on your PC screen.

## Note

- If a window does not appear automatically, click the "Start" button on your desktop and then click "Run". When the Run box is open, type in "D:\InstMenu.exe" where "D:" is the drive letter of your CD; then click "OK".

# Transferring Your Images

## Note on CARD LINK (for USB) operation

- Make sure Palmcorder power is not shut off during use, your PC system may become unstable, therefore it is recommended that the AC Adaptor be used as the power source. (Be especially careful when recording in M-CARD or CAMERA mode as the power eventually shuts off automatically if a tape is inserted.)

## Uninstalling Application Software

- 1 Click "Start," "Settings," and "Control Panel."
- 2 Double-click on "Add/Remove Programs" in the "Control Panel."
- 3 Select the application software you want to remove, and then click [Add/Remove].

### Note

- Before uninstalling CARD LINK (for USB), right-click on the CARD LINK (for USB) Monitor, then left-click on "Exit" to close CARD LINK (for USB) Monitor.
- If the "Locked File Detected" dialog box appears while uninstalling the CARD LINK (for USB), close CARD LINK (for USB) Monitor as described above, then click on [Retry].



## Connection

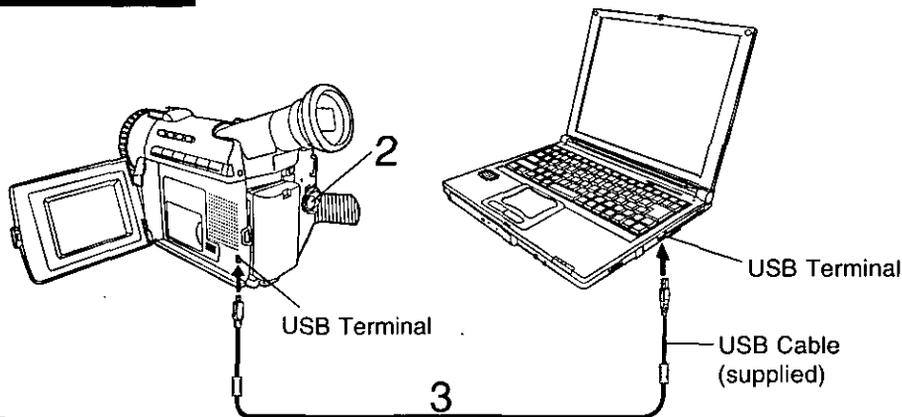

- 1 Turn on your PC.
- 2 Set the Palmcorder POWER to VCR.
- 3 Connect the Palmcorder to your PC (Windows) using the USB Cable (supplied).

### Note

- For extended use, it is recommended to use the AC Adaptor as a power source.

# Transferring Your Images

## One Touch Transfer

The images stored on the Memory Card can easily be transferred to the PC by pressing the TRANSFER Button.

### Note

- Before using this feature, make sure the CARD LINK (for USB) monitor icon is displayed.
- Double clicking the CARD LINK Monitor icon displays a dialog box in which the save location for the collective transfer can be changed.

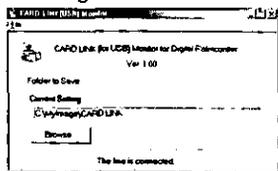

### 3 TRANSFER Button



## Before you begin

- Set POWER to OFF before inserting a recorded Memory Card. (See pages 32, 33.)
- Turn your PC on.

- 1 Set Palmcorder POWER to CAMERA or slide M-CARD Lock Switch to unlock and set to M-CARD. (See pages 9, 10.)
- 2 Connect the Palmcorder to your PC (Windows) using the USB Cable (supplied). (See page 55.)
  - "CONNECT WITH PC" is displayed on the LCD monitor.
- 3 Press TRANSFER.
  - CARD LINK (for USB) application is run automatically and images stored on the memory card are transferred to your PC and saved. (If an image to be transferred already exists, that image will be skipped over and not transferred.)

### Note

- JPEG image format and Bitmap files (only image data that can be played back on Palmcorder) can be transferred from the PC to the Palmcorder.

## Running the CARD LINK (for USB)

You can transfer images between the Memory Card and your PC.

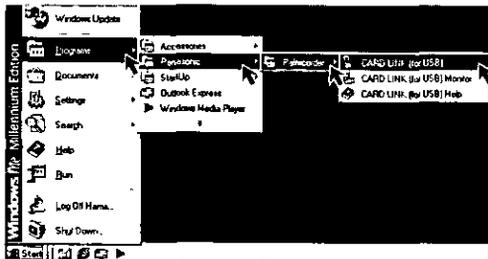

- 1 Repeat steps 1 and 2 above.
- 2 Click on "Start," "Programs," "Panasonic," "Palmcorder," then "CARD LINK (for USB)."
- 3 "CARD LINK (for USB)" is opened.

### Note

Refer to Help for information about application operations and Error messages.

## While CARD LINK (for USB) is running, do not perform the following operations...

The PC system may become unstable.

- Change the screen area or color pallet in the Display Properties window.
- Turn the Palmcorder power switch ON or OFF while connecting the Palmcorder to your PC using the USB Cable.
- Connect/disconnect the USB Cable.
- Insert/remove a Memory Card.

# Transferring Your Images

## Using Memory Card Image Data (CARD LINK (for USB))

Pictures captured with Palmcorder can be transferred to your PC.

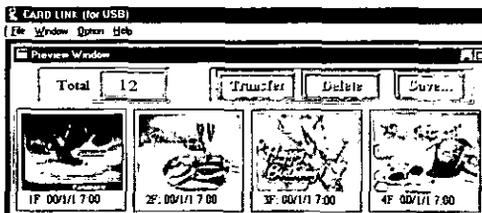

### Note

- If, while transferring the image to your PC, the displayed picture appears abnormal, restart the PC application and turn Palmcorder POWER off, and then back on.

## Using PC Image Data (CARD LINK (for USB))

You can use JPEG or Bitmap files from your computer for Photo Title (see page 38) by transferring them to the Palmcorder via PC connection.

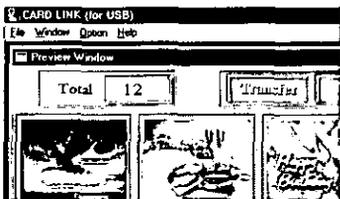

## Before you begin

- Set POWER to OFF before inserting a recorded Memory Card. (See pages 32, 33.)
- Make Palmcorder-PC connections. (See page 55.)
- Turn your PC on. (See page 55.)
- Set Palmcorder POWER to M-CARD. (See page 10.)
- Repeat steps 1 and 2 to run the CARD LINK (for USB). (See "Running the CARD LINK (for USB)" on page 56.)

- 1 Select the image data you want to transfer to your PC.
  - The selected image will be underlined in green.

- 2 Click on:

### Transfer

- The picture image is transferred to your PC and displayed. Transfer Dialog will appear on the PC. The image is captured when the full screen image appears on the PC.

### Delete

- Confirmation Dialog will appear on the PC. Click "OK". The selected images of the Memory Card are deleted.

### Save

- The picture image is transferred to your PC and displayed. [Save as] dialog box will appear.

- 1 Click on "File," then Click on "Open."

- At your PC, please select and open the data (.jpg or .bmp) you want to transfer to the Palmcorder.

- 2 Click on "File," select "Data out to camera," then select Fine or Normal mode.

- Your computer image data is transferred to the Palmcorder.

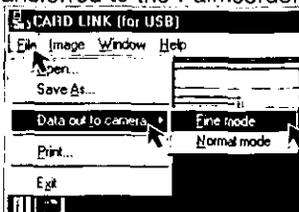

# Transferring Your Images (i.LINK)

## PC Connection with DV Interface Cable (i.LINK)

A live image can be transferred directly to your PC (Personal Computer) via a DV Interface Cable (i.LINK) (not supplied) using products and software from a number of editing software companies including Digital Origin, Canopus, and Pinnacle.

Using Products from these companies allows you to capture and edit live images onto your PC using the DV interface (i.LINK).

For more detailed information regarding editing software products from these companies, please visit their websites at:

[www.digitalorigin.com](http://www.digitalorigin.com)

[www.justedit.com](http://www.justedit.com)

[www.pinnaclesys.com](http://www.pinnaclesys.com)

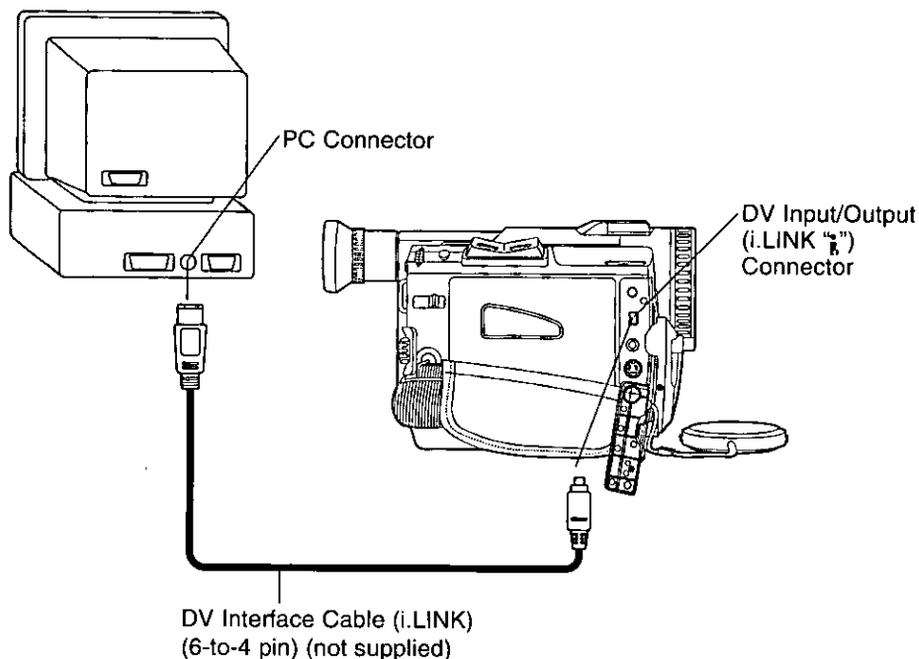

### Note

- PC must be equipped with an i.LINK terminal.
- During Palmcorder playback, do not disconnect the DV Interface Cable (i.LINK) or turn the Palmcorder off as this may cause PC hang-up error to occur.
- 1394 (i.LINK) interface must conform to OHCI (Open Host Controller Interface Specification).

# Palmcorder Accessory System

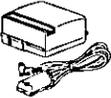
Accessory #	Figure	Description	Price
PV-DAC11		AC Adaptor with AC Cable and DC Cable	\$120.00
CGR-D08A/1B (Replaces CGR-D120A/1B)		800mAh / 1 h 30 min, Battery Pack	\$69.95
CGR-D16A/1B (Replaces CGR-D220A/1B)		1600mAh / 3 h, Battery Pack	\$99.95
CGP-D28A/1B		2800mAh / 5 h, Battery Pack	\$129.95
CGR-D53A/1K (Replaces CGR-D815A/1B)		5300mAh / 9 h, Battery Pack	\$229.95
PV-DDC9		DV Interface Cable (i.LINK) (4-pin to 4-pin)	\$55.00
PV-DLT9		Color Enhancement Light	\$39.95
PV-DRC9		IR Remote Control	\$29.95
PV-H150		Carrying Case	\$49.95
PR-SD064 PR-SD032 PR-SD016		64 MB SD Memory Card 32 MB SD Memory Card 16 MB SD Memory Card	\$179.95 \$119.95 \$79.95
BN-SDCAPU/1B		SD USB Reader/Writer (compatible with MultiMediaCard)	\$79.95
BN-SDABPU/1B		SD PCMCIA Adaptor (compatible with MultiMediaCard)	\$79.95

For Your Information

# Palmcorder Accessory System

## Concerning the MultiMediaCard and SD Memory Card

### MultiMediaCard

The MultiMediaCard is a compact, lightweight and removable external memory card. A great many fun-filled titles (preset titles) have been recorded on the supplied MultiMediaCard.

These preset titles will also be erased when the Card is formatted.

### SD Memory Card

The SD Memory Card (optional), which is virtually the same size as the MultiMediaCard, is an external memory card with an even bigger memory capacity. It has a write protect switch to prevent the data writing and card formatting, and it comes with a copyright protection function that complies with the SDMI (Secure Digital Music Initiative) standard. Music play is possible only with an SD Memory Card.

- SD Logo is a trademark.
- Portions of this product are protected under copyright law and are provided under license by ARIS/SOLANA/4C.



# Notes On Operations

## Cleaning EVF (Electronic Viewfinder)

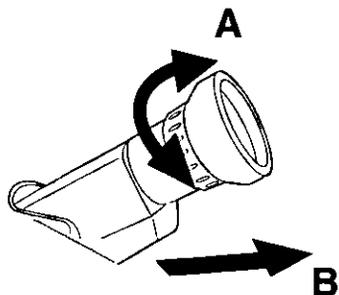

- 1 Turn the Eyepiece counterclockwise 1/8 of a turn.
- 2 Pull the Eyepiece free. Remove any lint or dust particles with a soft, clean cloth being careful not to scratch the glass surfaces.
- 3 **To re-install the Eyepiece**  
Line up the marks on the Eyepiece with the grooves inside the EVF shaft and attach. Turn it clockwise 1/8 of a turn to lock in place.

## Approximate Brightness Values

Your Palmcorder has been designed for normal scene illumination of 150 footcandles (1500 lx). However, the Palmcorder may be used at F1:1.6, if illumination is more than 0.5 footcandles (5 lx).

The table below shows the color temperature for reference.

PALMCORDER SETTINGS	NATURAL LIGHT CONDITIONS	KELVIN COLOR TEMPERATURE	ARTIFICIAL LIGHT SOURCE	COLOR TINT MIXTURE
(Amber Filter Range) ↑ --- "OUTDOOR" "AUTO" ↓ --- "INDOOR" (Blue Filter Range)	• Fair weather, blue sky	10,000	• Color television	Bluish
	• Slightly cloudy sky	8,000		
	• Cloudy or rainy sky	7,000		
	• Sunlight in clear weather at midday	6,500	• Fluorescent lamp (Daylight)	Whitish
	• Average sunlight in clear weather	6,000	• Camera flash bulb	
	• Sunlight 2 hours after sunrise and before sunset	5,500	• Blue lamp for photography	
	• Sunlight 40 min. after sunrise and before sunset	5,000	• Fluorescent lamp (White)	
	• Sunlight 30 min. after sunrise and before sunset	4,500	• Normal flash bulb	Yellowish
	• Sunlight 20 min. after sunrise and before sunset	4,000	• Fluorescent lamp (Off-white)	
		3,500	• Tungsten lamp for photography	
	3,200	• Halogen lamp	Reddish	
	2,800	• Iodine lamp		
	2,000	• Tungsten lamp		
		• Acetylene lamp		
			• Kerosene lamp	
			• Candlelight	

# Specifications

<b>Power Source:</b>	Palmcorder: 7.2 V DC (Battery) 7.8 V DC (AC Adaptor) AC Adaptor: 110/120/220/240 V AC, 50/60 Hz Battery: Lithium-Ion Type DC 7.2 V
<b>Power Consumption:</b>	Palmcorder: 7.2 V DC 6.5 W (Max. 9.5 W) AC Adaptor: 18 W 1 W (when not in use.)
<b>Digital Interface</b>	USB/i.Link (IEEE1394)
<b>Video Signal:</b>	EIA Standard (525 lines, 60 fields) NTSC color signal
<b>Video Recording System:</b>	2 rotary heads. helical scanning system
<b>Audio:</b>	12 bit (32 kHz) 4 tracks 16 bit (48 kHz) 2 tracks
<b>Pick-Up System and Device:</b>	One integral color filter Charge Coupled Device (CCD)
<b>Lens:</b>	18:1 zoom lens, F1:1.6 with auto iris control Focal length: 3.6 mm - 64.8 mm Power zoom function Lens filter diameter: 43 mm
<b>Viewfinder:</b>	0.4 inch (10.2 mm) Electronic Viewfinder
<b>LCD Monitor:</b>	2.5 inch (63.5 mm) Liquid Crystal Display
<b>Minimum Illumination Required:</b>	5 lx (F1:1.6) 0.5 footcandles
<b>Image Storage (supplied 8 MB MultiMediaCard)</b>	320 x 240 pixels (NORMAL mode) 640 x 480 pixels (FINE mode) Approx. 240 images (NORMAL mode) Approx. 60 images (FINE mode)
<b>Image Format</b>	JPEG (Design Rule for Camera File System)
<b>Operating Temperature:</b>	32 °F~104 °F (0 °C~40 °C)
<b>Operating Humidity:</b>	10 %~75 %
<b>Weight:</b>	Palmcorder: 1.50 lbs. 0.68 kg AC Adaptor: 0.35 lbs. 0.16 kg
<b>Dimensions:</b>	Palmcorder: 3-3/8 (W) x 4-1/4 (H) x 7-1/2 (D) inch 85 (W) x 107.5 (H) x 191 (D) mm AC Adaptor: 2-3/4 (W) x 1-3/4 (H) x 4-1/2 (D) inch 70 (W) x 45 (H) x 115 (D) mm

Weight and dimensions shown are approximate.  
Designs and specifications are subject to change without notice.

# Before Requesting Service

## Cleaning Care for Video Heads

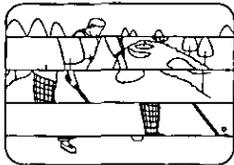

Clogged Video Head

**(a) Video Head Cleaning:** Normally, your Palmcorder will not require head cleaning. However, it is possible that the heads may become clogged due to dust in the air, playing damaged tapes, long term use, etc. If "NEED HEAD CLEANING" appears for 5 seconds in the EVF or LCD monitor, the heads may require cleaning.

**(b) Cleaning the Heads:** It is recommended that head cleaning be performed by a qualified service technician. Please contact your nearest Panasonic Servicenter. An alternate solution is to obtain a head cleaning cassette. Please use Panasonic cleaning cassette (AY-DVMCL). Be sure to follow the cleaning instructions carefully. Excessive use of the head cleaning cassette could shorten video head life.

Use this cassette only when a head clogging symptoms occur.

Refer servicing to qualified service personnel.

## Tape Operations Caution

- When you go from function to function (PLAY, FF, REW etc.), please note that the unit will not accept a new function operation until the previous operation is complete.
- The POWER Button and all function buttons, (PLAY, FF, REW, etc.) are only operational after the tape has been completely loaded.

## Lens Hood Area Operation Caution

When the following accessories are attached and the zoom is set to maximum wide angle, the four corners of the screen may appear darker:

- Wide or Telephoto conversion lens (optional).
- A filter (optional), etc. and then the lens hood.
- Two filters (optional).

## Self Diagnostic System

If any of the following numbers appear on-screen, the Palmcorder may need service. Do not remove the battery (if attached) and write down the displayed number on page 66. Then, take the Palmcorder to a servicenter for repair.

Error No.	Description
U11	Card Error
U12	Card Error
U13	Card Error
U14	Card/Palmcorder Dialogue Error
U15	No Card Memory
U16	Captured image limit exceeded
U17	Captured image limit exceeded
U30	Error other than above

# Before Requesting Service

If you have a problem with your Palmcorder, it may be something you can correct yourself.

Check the list below for symptoms and corrections.

Symptom	Correction
No picture in the EVF or LCD Monitor...	<ul style="list-style-type: none"><li>• Make sure the Power Source is connected. (pp. 11, 12)</li><li>• Make sure the POWER switch is set to VCR or CAMERA. (pp. 22, 27)</li><li>• Check the Dew Indicator. (p. 21)</li><li>• Make sure the Battery is fully charged. (p. 11)</li><li>• Make sure all necessary cables are connected correctly and firmly. (p. 12)</li><li>• Make sure the Lens Cap is removed. (p. 22)</li></ul>
Video cassette cannot be inserted...	<ul style="list-style-type: none"><li>• Make sure the Power Source is connected. (pp. 11, 12)</li><li>• Insert the cassette record tab up, window side facing out. (p. 9)</li></ul>
Video cassette cannot be removed...	<ul style="list-style-type: none"><li>• Make sure the Power source is connected. (pp. 11, 12)</li></ul>
No operation starts when operation buttons are pressed...	<ul style="list-style-type: none"><li>• Check the Dew Indicator. (p. 21)</li></ul>
Recording cannot be done...	<ul style="list-style-type: none"><li>• Make sure the record tab is closed. (p. 6)</li><li>• Check the Battery Indication. (p. 19)</li></ul>
Auto Focus does not operate...	<ul style="list-style-type: none"><li>• Make sure FOCUS is set to AUTO. (p. 47)</li><li>• Make sure the unit is ON and set to CAMERA mode. (p. 22)</li></ul>
Sound from microphone cannot be monitored...	<ul style="list-style-type: none"><li>• Make sure the unit is set to REC or REC/PAUSE mode.</li></ul>
Sound cannot be heard...	<ul style="list-style-type: none"><li>• Make sure the Audio on the VCR MENU is set to ST1. (pp. 17, 51)</li></ul>

# Request for Service Notice

Please photocopy this form when making a request for service notice.

## Request for Service Notice:

In the unlikely event this product needs service.

- Please include your **proof of purchase**. (Failure to do so will delay your repair.)
  - To further speed your repair, please provide an explanation of what is wrong with the unit and any symptom it is exhibiting.
- 
- 
- 

Mail this completed form and your Proof of Purchase along with your unit to:  
Panasonic Services Company  
1705 N. Randall Road  
Elgin, IL. 60123-7847  
Attn: Camcorder Repair

Please write the displayed Self Diagnostic number here. (See page 64.)

# Index of Controls

## Front View

**D.ZOOM Button**

See page 40.

**EIS Button**

See page 39.

**TRANSFER Button**

See page 56.

**Lens**

**Remote Sensor**

See page 25.

**Lens Cap**

See pages 8, 22.

**FADE Button**

See page 48.

**A.DUB Button**

See page 50.

**BACK LIGHT Button**

See page 48.

**MULTI Button**

See page 46.

**Built-in Twin Capsule 2-Way Microphone System**

## Side View

**PHOTOSHOT Button**

See page 34.

**TAPE EJECT Switch**

See pages 7, 9.

**Cassette Compartment Cover**

See page 7.

**Hand Strap**

See page 8.

**Built-in Light Mount**

See page 7.

**PHONE Jack**

See page 27.

**DV Input/Output (i.LINK "i") Connector**

See pages 53, 58.

**A/V Output Connector**

See pages 31, 52.

**S-VIDEO Output Connector**

See page 52.

For Your Information

# Index of Controls

## Rear View

**Vision Adjustment Control**  
See pages 9, 22.

**Electronic Viewfinder (EVF)**  
See page 9.

**Menu Button**  
See pages 13, 14.

**Battery Release Button**  
See pages 11, 12.

**POWER Lamp**  
See page 22.

**REC/PAUSE Button**  
See pages 9, 22.

**Shoulder Strap Attachment Ring**  
See page 8.

**JOG KEY**  
See pages 13, 14.  
**VOLUME KEY**  
See page 27.  
**M.FOCUS DIAL**  
See page 47.

**POWER ZOOM Button**  
See pages 22, 40.

**Shoulder Strap Attachment Ring**  
See page 8.

**M-CARD Lock Switch**  
See page 10.

**POWER Switch (CAMERA•VCR•OFF•M-CARD)**  
See pages 9, 10.

## Rear View

**M-CARD Door**  
See page 10.

**LCD (Liquid Crystal Display) Monitor**  
See pages 9, 10, 23, 27.

**LCD-OPEN Button**  
See pages 9, 10, 23, 27.

**CARD EJECT Switch**  
See page 10.

**Built-in Speaker**  
See page 27.

**DC IN Terminal**  
See page 12.

**USB Terminal**  
See page 55.

## Side View

**REW Button**  
See pages 10, 27.  
**EDIT SEARCH Button**  
See pages 24.

**STOP Button**  
See pages 10, 27.  
**M-STOP Button**  
See pages 34, 35, 36, 37.

**PLAY Button**  
See pages 10, 27.  
**M-PLAY Button**  
See pages 34, 35.

**FF Button**  
See page 28.  
**EDIT SEARCH Button**  
See page 24.

**PAUSE Button**  
See pages 28, 29, 50, 51, 52, 53.  
**CAMERA STILL Button**  
See pages 45.

**REC Button**  
See page 53.  
**M-DEL Button**  
See pages 35, 36, 37.

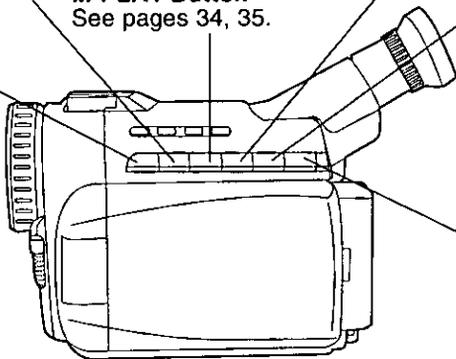

## Underside View

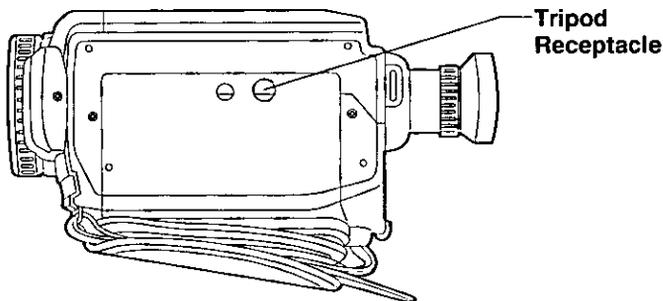

## AC Adaptor

**POWER Lamp**  
See pages 11, 12.

**CHARGE Lamp**  
See page 11.

**VCR DC Output Connector**  
See page 12.

**AC Power Cord**  
See pages 11, 12.

### CAUTION:

This unit will operate on 110/120/220/240 V AC. An AC plug adaptor may be required for voltages other than 120V AC. Please contact either a local or foreign electrical parts distributor for assistance in selecting an alternate AC plug. We recommend using the accessory power plug adaptor (VJSS0070) in an area which has special AC outlets.

# Index of Controls

## Color Enhancement Light (Optional)



**LIGHT RELEASE Button**  
See page 7.

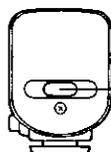

**LIGHT Button**  
See page 7.

## Remote Control (Optional)

**DATE/TIME Button**  
See pages 20, 25.

**DISPLAY ON TV Button**  
See pages 25, 31.

**A.DUB Button**  
See pages 25, 50.

**COUNTER/TC Button**  
See pages 19, 25.

**RESET Button**  
See pages 25, 51.

**REWIND/SEARCH Button**  
See pages 25, 28.

**MENU Button**  
See pages 13, 14, 51.

**REVERSE SLOW/ F. ADV Button**  
See pages 25, 28, 29.

**REVERSE INDEX SEARCH Button**  
See pages 25, 30, 41.

**STOP Button**  
See pages 25, 27.

**SET Button**  
See pages 13, 14, 25.

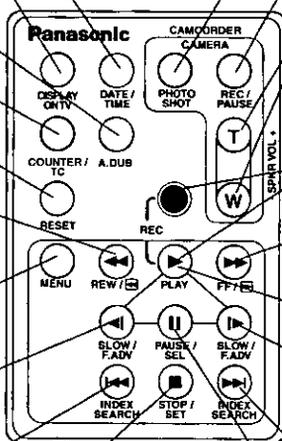

**PHOTOSHOT Button**  
See pages 25, 41.

**REC/PAUSE Button**  
See pages 22, 25.

**POWER ZOOM Switch**  
See pages 22, 25.  
**SPKR VOL +/-**  
See pages 25, 27.

**VIDEO REC Button**  
See pages 25, 53.

**FAST FORWARD/ SEARCH Button**  
See pages 25, 28.

**PLAY Button**  
See pages 25, 27, 53.

**FORWARD SLOW/ F. ADV Button**  
See pages 25, 28, 29.

**FORWARD INDEX SEARCH Button**  
See pages 25, 30, 41.

**PAUSE Button**  
See pages 25, 28, 53.

**SEL Button**  
See pages 13, 14, 25.

# Limited Warranty

Panasonic Consumer Electronics Company,  
Division of Matsushita Electric Corporation  
of America, One Panasonic Way  
Secaucus, New Jersey 07094

Panasonic Sales Company,  
Division of Matsushita Electric of Puerto Rico, Inc.  
AVE. 65 de Infantería, Km. 9.5 San Gabriel  
Industrial Park Carolina, Puerto Rico 00985

## PANASONIC Video Products

### Limited Warranty

Panasonic Consumer Electronics Company or Panasonic Sales Company (collectively referred to as "the Warrantor") will repair this product with new or refurbished parts, free of charge, in the USA or Puerto Rico, in the event of a defect in materials or workmanship as follows (all time periods commence from the date of the original purchase):

PRODUCT	PARTS	LABOR	SERVICE	CONTACT NUMBER
CAMCORDER	ONE (1) YEAR, EXCEPT CCD IMAGE SENSOR	NINETY (90) DAYS	Carry-In or Mail In	1-800-211-PANA(7262)
	CCD IMAGE SENSOR - SIX (6) MONTHS	NINETY (90) DAYS		
VCR	ONE (1) YEAR	NINETY (90) DAYS	Carry-In or Mail In	1-800-211-PANA(7262)
A/V MIXER	ONE (1) YEAR	NINETY (90) DAYS	Carry-In or Mail In	1-800-211-PANA(7262)
MONITOR- VCR Combination	ONE (1) YEAR, EXCEPT CRT	NINETY (90) DAYS	Carry-In: 21" CRT and Smaller In-home or carry-in: 22" CRT and Larger	1-800-211-PANA(7262)
	CRT - TWO (2) YEARS	CRT - NINETY (90) DAYS		

**Batteries** (if included) - New rechargeable batteries in exchange for defective rechargeable batteries for ten (10) days. Non-rechargeable batteries are not warranted.

**Tape** (if included) - New video cassette tape in exchange for a defective video cassette tape for five (5) days.

In-home, carry-in or mail-in service, as applicable, in the USA can be obtained during the warranty period by contacting a Panasonic Services Company (PASC) Factory Servicenter listed in the Service Directory. Or call toll free contact number listed above, to locate an authorized PASC Servicenter. Carry-in or mail-in service in Puerto Rico can be obtained during the warranty period by calling the Panasonic Sales Company telephone number listed in the Servicenter Directory.

This warranty is extended only to the original purchaser. A purchase receipt or other proof of the date of the original purchase is required before warranty service is rendered.

This warranty only covers failures due to defects in materials and workmanship which occur during normal use and does not cover normal maintenance, including, but not limited to, video and audio head cleaning. The warranty does not cover damage which occurs in shipment, or failures which are caused by products not supplied by the warrantor, or failures which result from accident, misuse, abuse, neglect, mishandling, misapplication, alteration, modification, faulty installation, set-up adjustments, improper antenna, inadequate signal pickup, maladjustment of consumer controls, improper operation, power line surge, improper voltage supply, lightning damage, commercial use such as hotel, office, restaurant, or other business or rental use of the product, or service by anyone other than a PASC Factory Servicenter or a PASC authorized Servicenter, or damage that is attributable to acts of God.

#### LIMITS AND EXCLUSIONS

There are no express warranties except as listed above.

THE WARRANTOR SHALL NOT BE LIABLE FOR INCIDENTAL OR CONSEQUENTIAL DAMAGES (INCLUDING, WITHOUT LIMITATION, DAMAGE TO RECORDING MEDIA) RESULTING FROM THE USE OF THIS PRODUCTS, OR ARISING OUT OF ANY BREACH OF THE WARRANTY. ALL EXPRESS AND IMPLIED

WARRANTIES, INCLUDING THE WARRANTIES OF MERCHANTABILITY AND FITNESS FOR PARTICULAR PURPOSE, ARE LIMITED TO THE APPLICABLE WARRANTY PERIOD SET FORTH ABOVE.

Some states do not allow the exclusion or limitation of incidental or consequential damages, or limitations on how long an implied warranty lasts, so the above exclusions or limitations may not apply to you.

This warranty gives you specific legal rights and you may also have other rights which vary from state to state.

If a problem with this product develops during or after the warranty period, you may contact your dealer or Servicenter. If the problem is not handled to your satisfaction, then write to the Consumer Affairs Department at the Panasonic Consumer Electronics Company address above.

SERVICE CALLS WHICH DO NOT INVOLVE DEFECTIVE MATERIALS OR WORKMANSHIP AS DETERMINED BY THE WARRANTOR, IN ITS SOLE DISCRETION, ARE NOT COVERED. COSTS OF SUCH SERVICE CALLS ARE THE RESPONSIBILITY OF THE PURCHASER.

warvid8/8/2000

For Your Information

# Servicenter List

For Product Information, Operating Assistance, Literature Request, Dealer Locations, and all Customer Service inquiries please contact:  
**1-800-211-PANA(7262)**, Monday-Friday 9am-9pm Saturday-Sunday 9am-7am, EST.  
or send e-mail : [consumerproducts@panasonic.com](mailto:consumerproducts@panasonic.com)

**Web Site:** <http://www.panasonic.com>

You can purchase parts, accessories or locate your nearest servicenter by visiting our Web Site.

## Accessory Purchases:

**1-800-332-5368 (Customer Orders Only)**

**Panasonic Services Company 20421 84th Avenue South, Kent, WA 98032**

**(6 am to 5 pm Monday - Friday; 6 am to 10:30 am Saturday; PST)**

**(Visa, Master Card, Discover Card, American Express, Check)**

## Product Repairs

### Centralized Factory Servicenter

Panasonic Services Company

**MAIL TO :** 1705 N. Randall Road,  
Elgin, IL 60123-7847

Attention: Digital Camera Repair

Please carefully pack and ship, prepaid and insured, to the Elgin centralized repair Factory Servicenter. While there will be added handling delays, you may bring your unit to one of the following locations who will then forward the unit to Elgin for repair.

Customer's in Puerto Rico, please ship or carry in to location below ("Service in Puerto Rico").

## Factory Service Center Locations

### CALIFORNIA

6550 Katella Avenue  
Cypress, CA 90630  
800 Dubuque Avenue  
S. San Francisco,  
CA 94080  
3878 Ruffin Road  
Suite A  
San Diego, CA 92123

### COLORADO

1640 South Abilene  
Street Suite D  
Aurora, CO 80012

### FLORIDA

3700 North 29th Avenue  
Suite 102  
Hollywood, FL 33020

### GEORGIA

8655 Roswell Road  
Suite 100  
Atlanta, GA 30350

### ILLINOIS

9060 Golf Road  
Niles, IL 60714  
1703 North Randall Road  
Elgin, IL 60123  
(Pick-up / Drop-off only)

### MARYLAND

62 Mountain Road  
Glen Burnie MD 21061

### MASSACHUSETTS

60 Glacier Drive,  
Suite G  
Westwood, MA 02090

### MINNESOTA

7850-12th Avenue South  
Airport Business Center  
Bloomington, MN 55425

### OHIO

2236 Waycross Road  
Civic Center Plaza  
Forest Park, OH 45240

### PENNSYLVANIA

2221 Cabot Blvd. West  
Suite B  
Langhorne, PA 19047

### TEXAS

13615 Welch Road  
Suite 101  
Farmers Branch,  
TX 75244

### WASHINGTON

20425-84th Avenue  
South  
Kent, WA 98032

### HAWAII

99-859 Iwaiwa Street  
Aiea, Hawaii 96701  
Phone (808) 488-1996  
Fax (808) 486-4369

## Service in Puerto Rico

**Matsushita Electric of Puerto Rico, Inc. Panasonic Sales Company/Factory Servicenter:**  
Ave. 65 de Infanteria. Km. 9.5 San Gabriel Industrial Park Carolina, Puerto Rico 00985  
Phone (787) 750-4300 Fax (787) 768-2910

As of January 2001

## Inserte de la batería

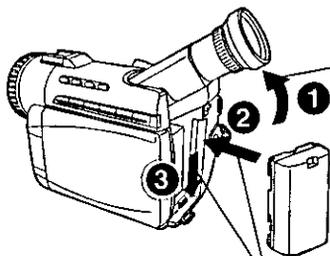

## Antes de comenzar

- Cargue la batería. (Página 11.)

**1** Incline el visor hacia arriba.

**2** Coloque la batería y deslícela hacia abajo hasata que quede bloqueada con un clic.

## Inserte el Cassette

**1** Ajuste el interruptor de alimentación (POWER) a la posición VCR o CAMERA.

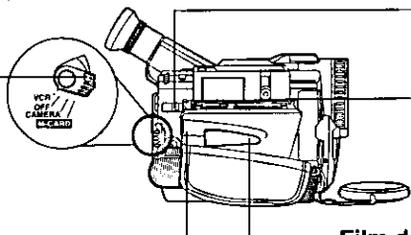

**2** Deslice el interruptor de expulsión de cinta (TAPE EJECT) para abrir la tapa del compartimento del cassette.

**3** Introduzca un cassette con la parte de la ventana hacia arriba.  
• Asegúrese de que la lengüeta de grabación esté cerrada. (Página 6.)

**4** Presione la marca PUSH TO CLOSE (EMPUJAR PARA CERRAR) para cerrar la tapa del compartimento del cassette.

Film de protección

### Nota

- Retire la película protectora antes de utilizarlo.

## Grabación con la cámara

Cuando el monitor LCD se encuentra totalmente abierto, el visor se DESACTIVA automáticamente.

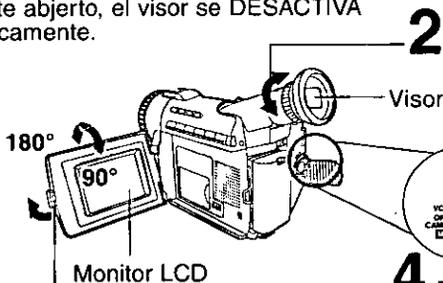

**2** Ajuste el control de ajuste de visión según lo desee.

**1** Ajuste el interruptor de alimentación (POWER) a la posición CAMERA.

**3** Presione el botón de apertura del LCD (LCD-OPEN) para desbloquear el monitor LCD. Balancee abriéndolo completamente y ajuste el ángulo.

**4** Presione el botón de grabación/pausa (REC/PAUSE) para iniciar la grabación. Vuelva a pulsar el botón de grabación/pausa (REC/PAUSE) para hacer una pausa en la grabación.

# Spanish Quick Use Guide/Guía Para Uso Rápido

## Introducir la Tarjeta de memoria\*

### Antes de comenzar

- Cargue la batería. (Página 11.)

\*Tarjeta de Memoria: Tarjeta MultiMedia o Tarjeta de Memoria SD (Página 60.)

- Asegúrese de introducir la Tarjeta de memoria antes de utilizar la tarjeta PhotoShot. (Página 32.)

A continuación se indican una lista de Tarjetas de Memoria soportadas por esta unidad.

Tarjeta de memoria	Capacidad
Tarjeta MultiMedia (LSFT0198A) (suministrado)	8 MB
Tarjeta MultiMedia (Marca de fábrica SanDisk)	8 MB, 16 MB
Tarjeta de Memoria SD (opcional) (Página 59.)	16 MB, 32 MB, 64 MB

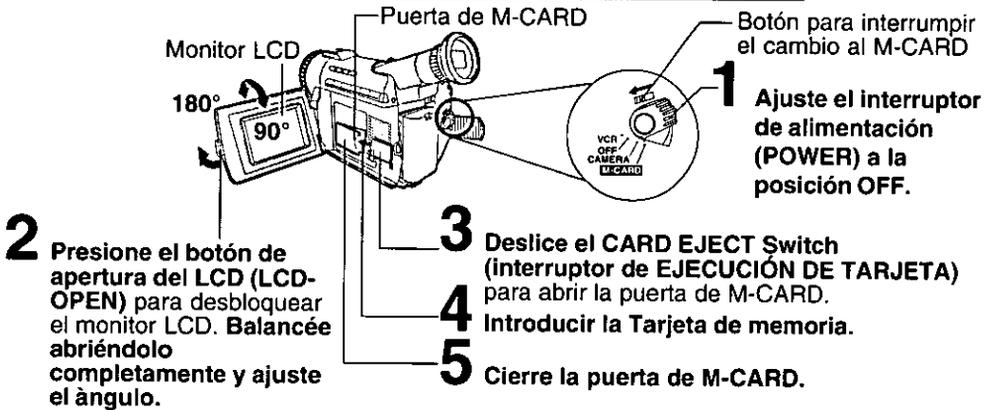

## Para ver la reproducción en el LCD (pantalla de visualización de cristal líquido)

Cuando el monitor LCD se encuentra totalmente abierto, el visor se DESACTIVA automáticamente.

### Antes de comenzar

- Cargue la batería. (Página 11.)

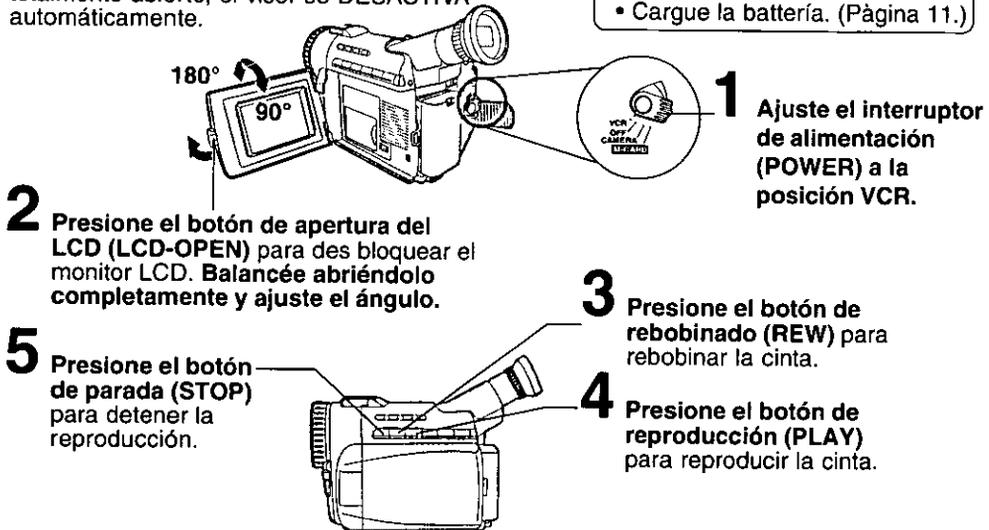

<b>A</b>		
AC Adaptor	6, 11, 12, 59	
Accessories (Optional)	59	
Accessories (Supplied)	6	
A/V Cable	6, 31, 52	
Audio/Video Fade In/Out	48	
Auto Focus	47	
<b>B</b>		
Backlight	48	
Battery Pack	6, 9, 11, 59	
Battery Remaining Indication	19	
Battery Warning	21	
Before Requesting Service	64, 65	
Blank Search	25	
<b>C</b>		
CARD EJECT Switch	10	
Camera Recording	22, 23, 24, 25	
Cleaning Care for Video Heads	64	
Clock Battery	21	
Clock Set	13	
Color Enhancement Light	7, 59	
Copying from Digital Equipment	53	
Copying your Tapes	52	
<b>D</b>		
Date and Time Indication	20	
DC Power Cable	6, 12, 59	
DEW Indication	21	
Digital E.I.S.	39	
Digital Functions	44	
Digital PhotoShot	41	
Digital Video Cassette Tape	6	
Digital Zoom	40	
Dubbing over Audio (Microphone)	50, 51	
DV Interface Cable (i.LINK)	53, 58, 59	
<b>E</b>		
Edit Search	24	
Erase Protection Tab	6	
EVF/LCD Monitor Indications	19, 20, 21	
<b>H</b>		
Hand Strap	8	
High Speed Shutter	49	
<b>J</b>		
Jog Search	29	
<b>L</b>		
Lens Cap	6, 8, 22	
Limited Warranty	71	
<b>M</b>		
Macro Focus	47	
Manual Focus	47	
Memory Counter	19	
MENU OSD	14, 15, 16, 17, 18	
Memory Card	6, 10, 59	
M-CARD Door	10	
<b>P</b>		
PC Cable	6, 55	
PC Connection	55, 58	
Picture in Picture (PiP)	45	
PLAY Indicator	20	
Playback	27, 28, 29, 30, 31	
Power Supply	11, 12	
Program AE	43	
<b>R</b>		
REC Indicator	20	
Recording Still Pictures	42	
Remote Control	25, 26, 59	
Request for Service Notice	66	
<b>S</b>		
Safety Precautions	2	
Servicenter List	72	
Set the Date and Time	13	
Shoulder Strap	6, 8	
Special Effects Playback	28, 29, 30	
Specifications	63	
STILL Picture	28	
Strobe Multi Mode	46	
<b>T</b>		
Tape Remaining Indications	19	
Tape Speed	6	
Tape Warning	21	
<b>V</b>		
VHF Connecting Cable	52	
Volume Display	27	
<b>W</b>		
White Balance	42	
<b>Z</b>		
Zoom In/Out	40	

---

**Panasonic Consumer Electronics  
Company, Division of Matsushita  
Electric Corporation of America**  
One Panasonic Way Secaucus,  
New Jersey 07094

**Panasonic Sales Company ("PSC"),  
Division of Matsushita Electric of  
Puerto Rico, Inc.**  
Ave. 65 de Infantería, Km. 9.5  
San Gabriel Industrial Park  
Carolina, Puerto Rico 00985



Printed in Japan  
LSQT0442A  
S0101A0